



В. Хорев



ЯПОНСКИЙ МЕЧ *ДЕСЯТЬ ВЕКОВ СОВЕРШЕНСТВА*

ЯПОНИСКИЙ МЕЧ

ДЕСЯТЬ ВЕКОВ
СОВЕРШЕНСТВА



Посвящается Юрию Андреевичу Копытину

Японские мечи служат не для того,
чтобы убивать или увечить людей.

Их предназначение -
поддерживать власть и защищать народ,
подавлять дьявола и изгонять зло.
Меч - душа самурая, самурай носит меч
как символ служения своему назначению.
Меч постоянно напоминает о долге тому,
кто правит людьми.

(Эйдзи сикава)



	7
1.	15
2.	28
3.,	49
4.	74
5.	90
6.	102
7.	113
8.	120
9.	136
10.	152
	171
	174
	185
	189



П
Р
Е
Д
К
С
Л
О
В
К
Е

»)

(« ,
(« »).

« »,

»), « , »,

(« -

« ».

?

(« »)

« ».

?

?

(!)

XXI

— ()

« » — « »

«Drang nach Westen»

()

« — »

XIX

(), XVIII (-)

« »

XX

« »

(—)

« »

— () —



1
ИСТОРИИ
СТРАНЦЫ

— , — : — !)

(. .)

(...)

« », -

(, , , ,), -

« » . -

— « » (« »),

712 .

IV

(334 . . . 300 . . .) «

», .

(Tsurugi), (Ken), « »

« » (

(Chokuto)

« » { -),

« » (Nihon

),

:



:

1.

2.

3.

IV

(!)

(Nihon To)

II-III

V

I.

. . . « ») V VIII . -
 , -
 , — , , -
 , III—IV , VIII ,
 , « - » : (), -
 () ().
 , , -
 , — , , , -
) XX (,
 , , (710-794) (794-1185) —
 , , -
 , « », — , -
 , , ()
 , « » — « , » , « ».
 « » , « » ,
 : « — » XII , -
 , « ...» , -
 , () -
 (1185-1333) ,



()

« »

(« »)

XIII

().

(1333-1392)



2 — (, XVIII) 2,84 .

80 , 2,25 ,

1331 . 1334 .

(),

« »,

— « - » (« ») « - » (« - »).



« » (,)
1,5-1,8 ,
« » .



(),

« !

?»

(Koto) —

1596 .,

(Shinto) —

1790

(Shin-Shinto) —
1790 1876 .

(Gendaito) — 1876

— « » (1500-1595 .).

(Keicho Shinto) — « » (1595-1615 .).

(Kanbun Shinto) — , 1661 1673 . (),

(Bakumatsu) —

(), 1853 1868 .

(Meiji-To) — (1868-1912 .).

- (Taisho-To) — (1912-1925).

- (Showa-To) — (1925-1989).

- (Shinsaku-To) — « » , 1955 .
« » ,

XX :

- (Gunto) — 1876 1945 .

- (Kio Gunto) — « » , , -

- (Shin Gunto) — « » ,

- (Kai Gunto) — -

, , .
« » , -

· , -
· · ·
, — , ,
, , ,
, « » , -
· « » »
, , -

XIV

, - , -
, -
, , -
, , -
, · , -
: — , -
, , -
, — ·
, · : —
« ! , : —
, , : , -
, · -
, ! , -

!»

),

(

Shinogi-ji

Mune.

(Ji Hada)

(Mokurue)

Macao

Midare).

Gunome Midare (

Gunome

Ha-agari Kiri Jiri (« » « »).

— (Tobiyaki),
(Ji).

Ichimai Boshi

« - » (Gokaden),

: - (Soshu Den), - (Bizen Den), - (Mino Den),
(Yamashiro Den) - (Yamato Den).

« » (),

— « »

« » « » XVII



XIV



() —
, —
,
« » ()
,
, - XVI
,
- (Bakyu-jutsu),
—
,
,
,
, (XXI
)
,
, —
,
— 300 000 100 000 (), (,
,
,
, 1977 ,
«Das Schwert des Samurai»,
,
* * *
,
« »,
, ,
.

Т
К
П
Ы

М
Е
Ч
Е
Й



(...)

« - » (Nihon To),

« », () —

), « ».
« » (« »).

(Katana)

(Tachi)

« »



« »

() .



(,) () ,



()

« - » ,





()
« - » (Same Kawa)



« - » — « »

()

()



« » — . —

· , ·

· : « , , -

· » . — , , -

· « » — -

· -

· , , · -

· , · -

· « » « » , ·

· , ·

· 1/3 · ,

· , · () . -

· : -

90 (72 — 18 —) , -

100-110 (80 20) . -

27-35 ·

· — , () — ·

25-27 , — 30 · ,

· « » ,

(Wakizashi)

(Tanto)

· —

· (—) . -

? , () 40 , -

· 30-40 , (30-60) . -

(20-40) ,



(« — « »)

(Kurigata)



(20),

(

),

« - » (Dai Sho),

« - » « - ».

« - ».

(, .)

« »

« », -



(Samenuri),

- XVIII

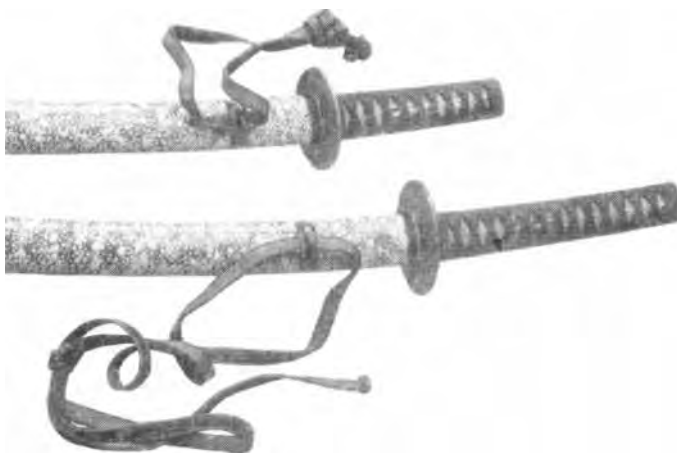

« -
),
 : « ».
),
)

« »,



« »,

(Tanto) —
30),

25 40 ()

(, ,).



(Hamidashi) —

(Aikuchi) —

(10 30),

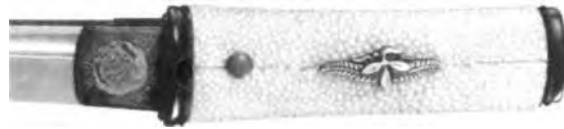

(Ura)

—
—
—
—
—

« »

* * *

(Yari)

(Naginata)

« »

— « ».

« » « ».

(« - »).



(. 1),

«

!»



«

»





() « »



(Yari)



(?)

?

2 ()

2,3 80-

?

« - ».

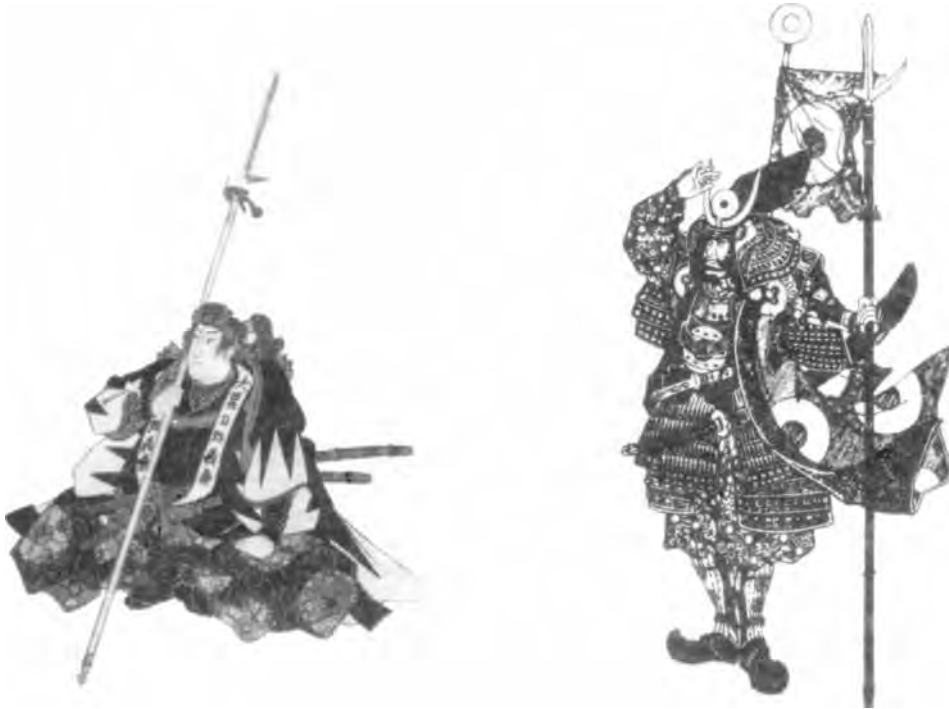



(,),

« »,

(),

« - » (« - »)

»



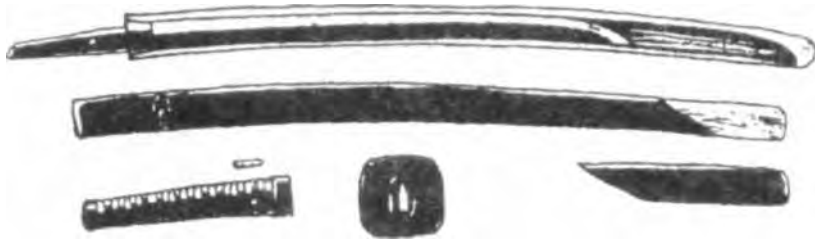

?)

(
« ».

()

« - »

:

« », « »

5

« »,

»). « »,

« - » (« -

(,),

, , -

* * *

, -

Ф
О
Р
М
Ы
М
Е
Ч
А



VIII

» (To-ken Kantei Dokuhon.

1. - (Toshin) (Sugata) —
2. - (Watari) — ()
3. (Sori) —
4. (Fumbari) —
« » (Machi).
5. (Kissaki) —
6. *Shinogi Ji* — Shinogi (Mune).
- 7.

8. (Kasane) —

9. (Niku Dori) —

(),

(Jigane) —

-xa a (Jihada) —

(Hamon) —



(Yasurime),

(Ji)



(!)



()

()

()

« »

(Hadori),

(Mune Yaki) —

(Yaki Doshi) —

(Machi),

(Boshi),

(Nakago).

—
—
— —
— —
— —

(*Watari*) —

(,), ()
{ , , }.

(*Sori*) —

(30-35),

Zori),

» (Chukan Zori). « »

« ».

« »

()

- **(Koshi Zori)**

« » « », « - ».
(Machi),
(Bizen Zori),
:

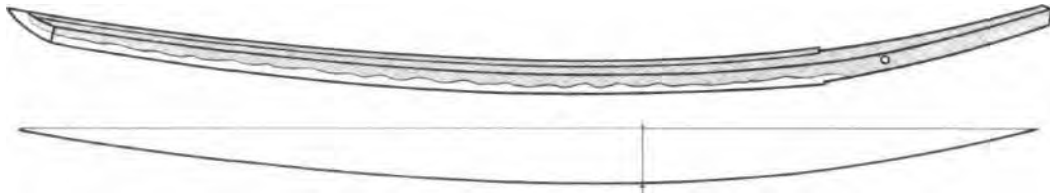

- **(Torii Zori)**

(« »). — - (Kio Zori). —

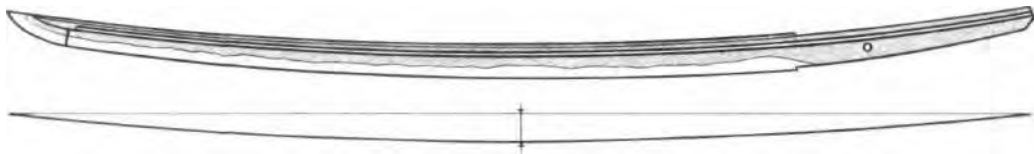

- **(Saki Zori)**

« » « , ».
:

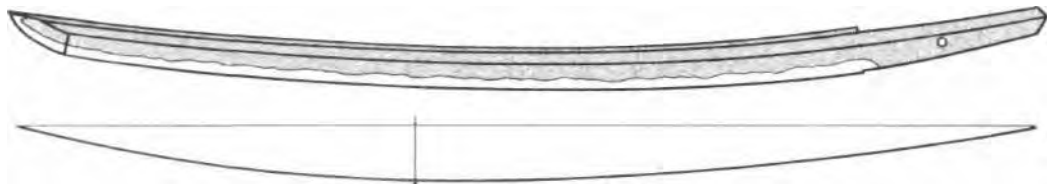

- , - (Uchi Zori),
(Takenoko Zori). « » (, , « »)

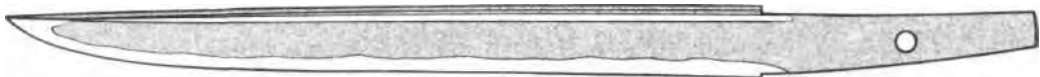

« » (Sugata) « » (Sukuri).

()

(Hira Zukuri)

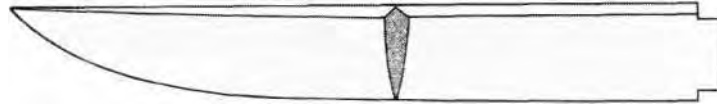

(Kiri Zukuri)

(Shinogi)

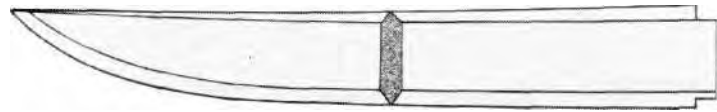

(Kata Kiri Zukuri)

500

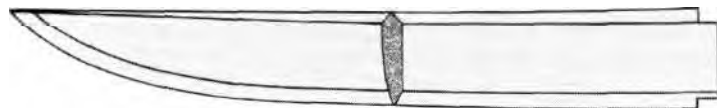

(Zukuri)

« ».

« -
1450 :.

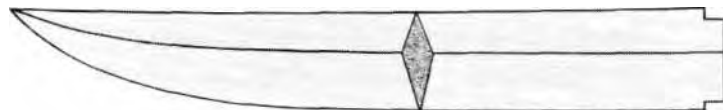

(Kanmuri Otoshi Zukuri)

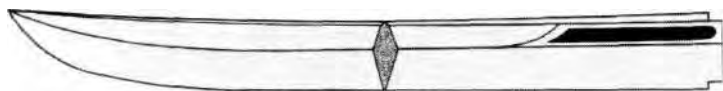

(U-no-kubi Zukuri)

(Shinogi Ji)

(Yokote),

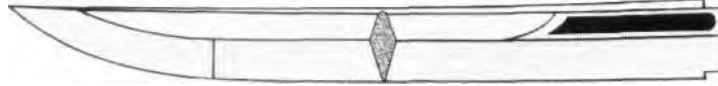

(Osoraku Zukuri)

(Kissaki)

?>

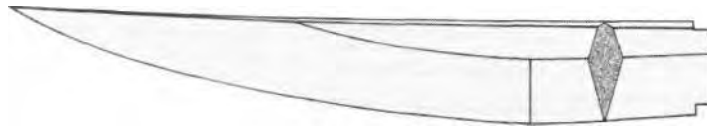

(Shinogi Zukuri)



(Shobu Zukuri)



794), (710-
 (Kissaki Zukuri)
 « ».
 (Kogarasu Maru Zukuri)
 « » (« »):

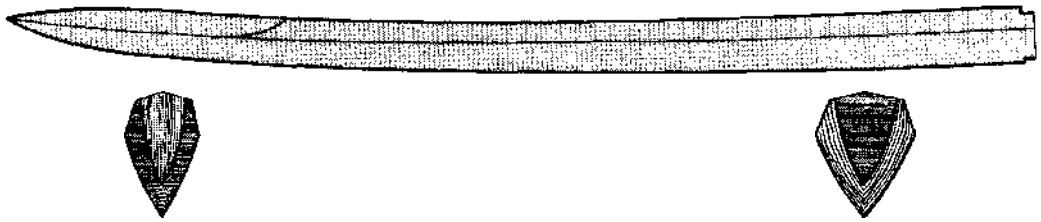

(Kissaki)

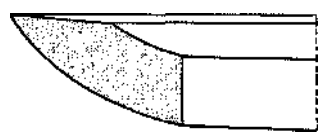

(Yokote). To,

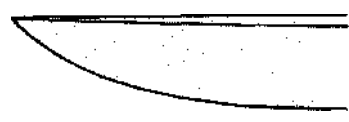

(« »).

(Fukura).

(« »)

(«

»):

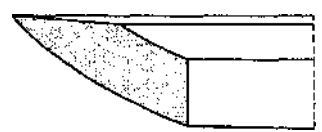
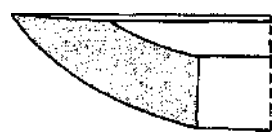

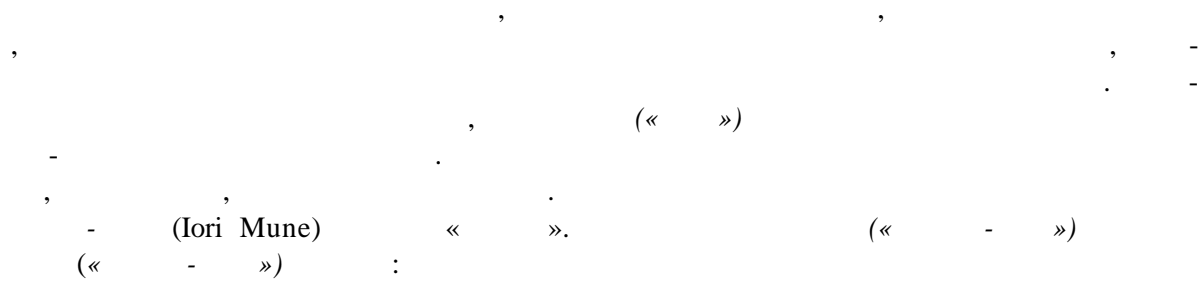
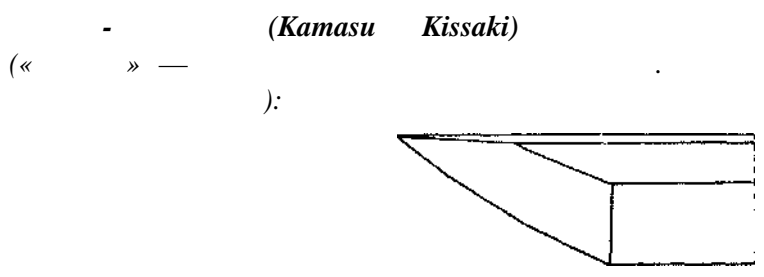
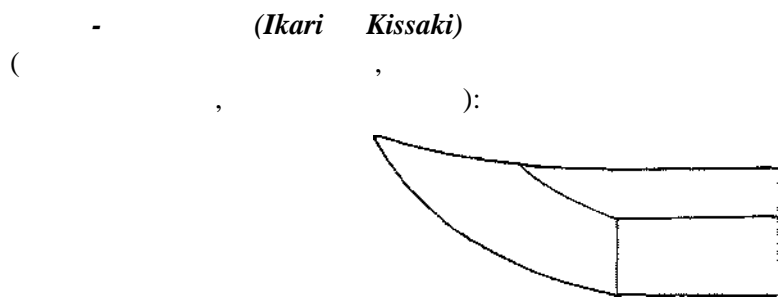
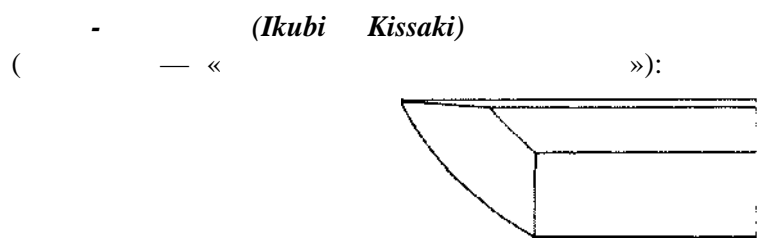
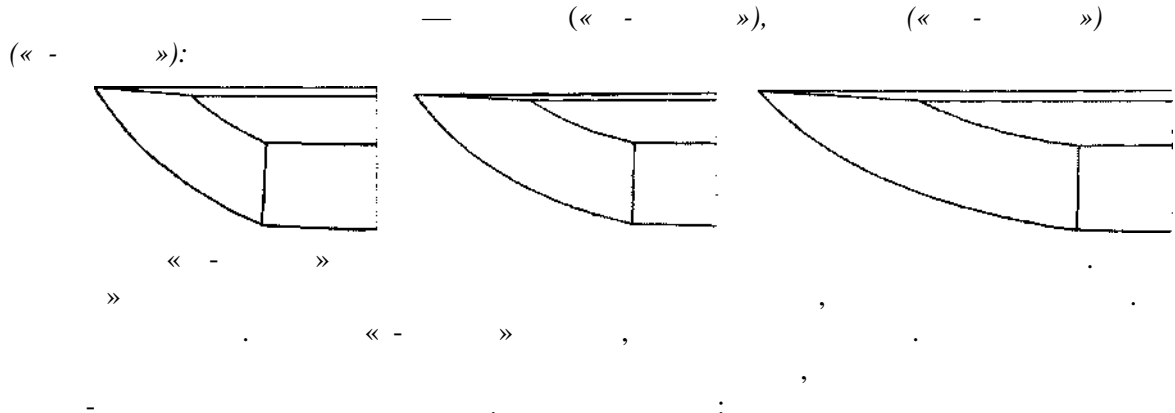

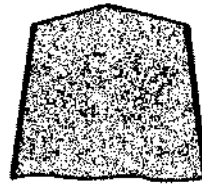
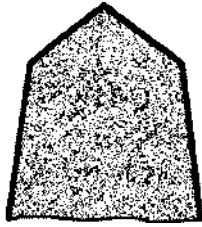

10%

»)

(« - - , - »)

(« - - »),

(« -

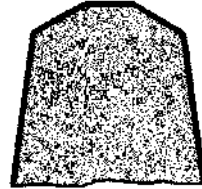
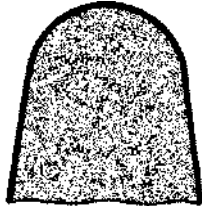
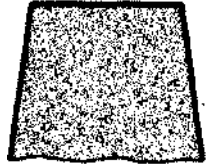

* * *

(Nakago).

(Mekugi),

(Mekugi-ana).

(!)

(Ubu Nakago).

(Suriage) —

(Mei)
(Orikaeshi Mei) —

(Gaku Mei) —

(Gata).

(Futsu Gata)

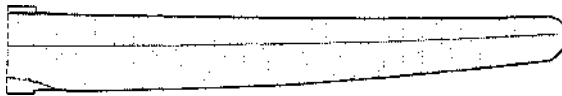

(Kiji Moto Gata)

« - »

« - »

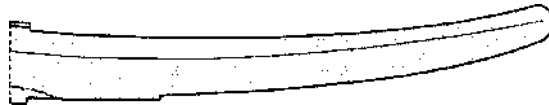

(Shiri Bari Gata)



(Gohei Gata)

« - »

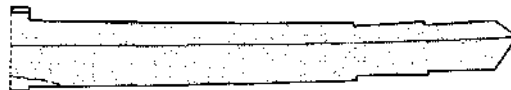

(Funa Gata)

« - »

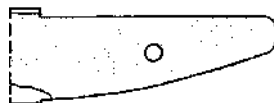

- (*Furisode Gata*)

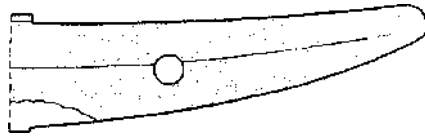

- (*Tanago Bara Gata*)

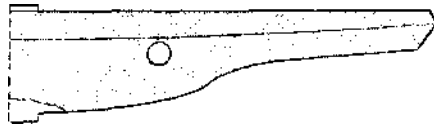

* * *

(Nakago Jiri),

- (*Yamashiro Jiri*)

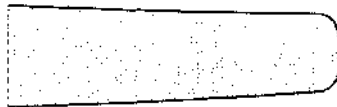

- (*Kengyo Jiri*)

« » —

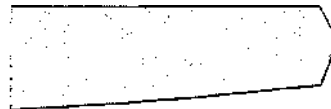

- (*Iriyamagata Jiri*)

- (« »):

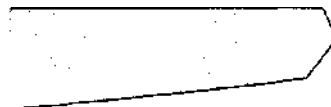

(Kuri Jiri)

« » ().

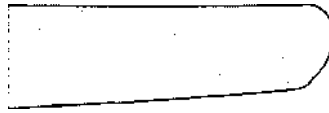

(Ha-agari Kuri Jiri)

« () ».

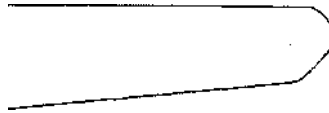

(Ichimonji Jiri)

« » (Hosho)



(Kiri Jiri)

— « ».

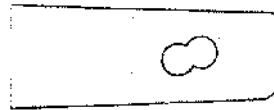

* * *

— « - » (Yasuri Mei) « - » —

« »

« >> —

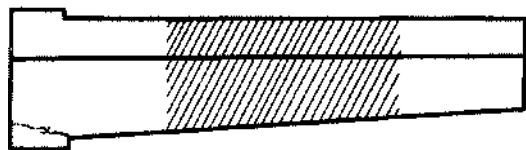

(Sujikai)

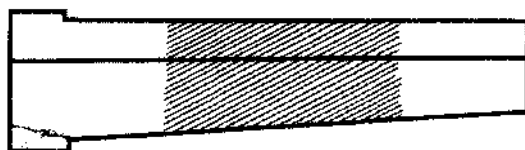

(O-sujikai)

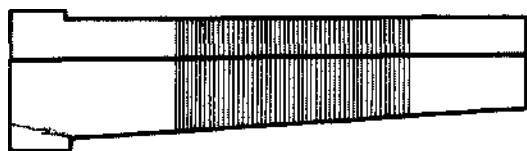

(Kiri)

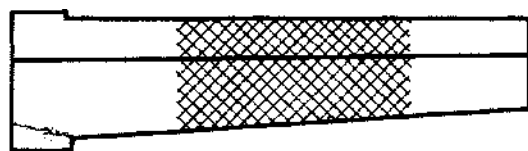

(Higaki)

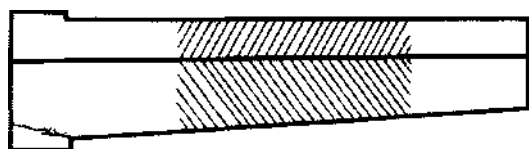

(Taka-no)

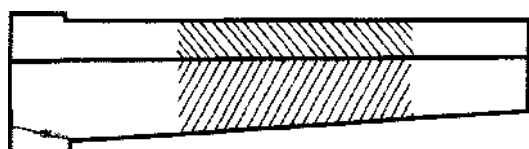

(Gyaku Taka-no)

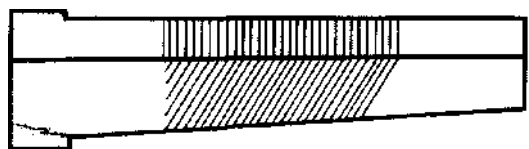

(Shinogiji-kiri/Hira-sujikai)

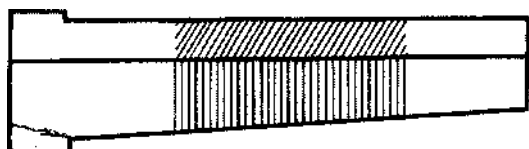

(Shinogiji-sujikai/Hira-kiri)

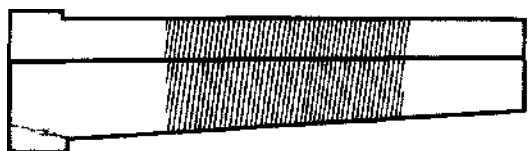

(Katte-sagari)

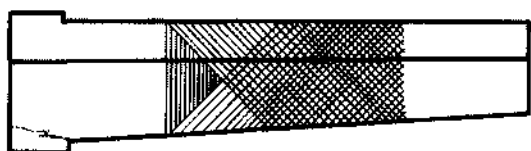

(Kesho Yasuri)



» « - » (O-sujikai).



: « » « - - » (« »).



(« - ») « - » (.).

— (Hamon).

()



« ».

Ji

«

» (Habuchi),

, « »

() ()

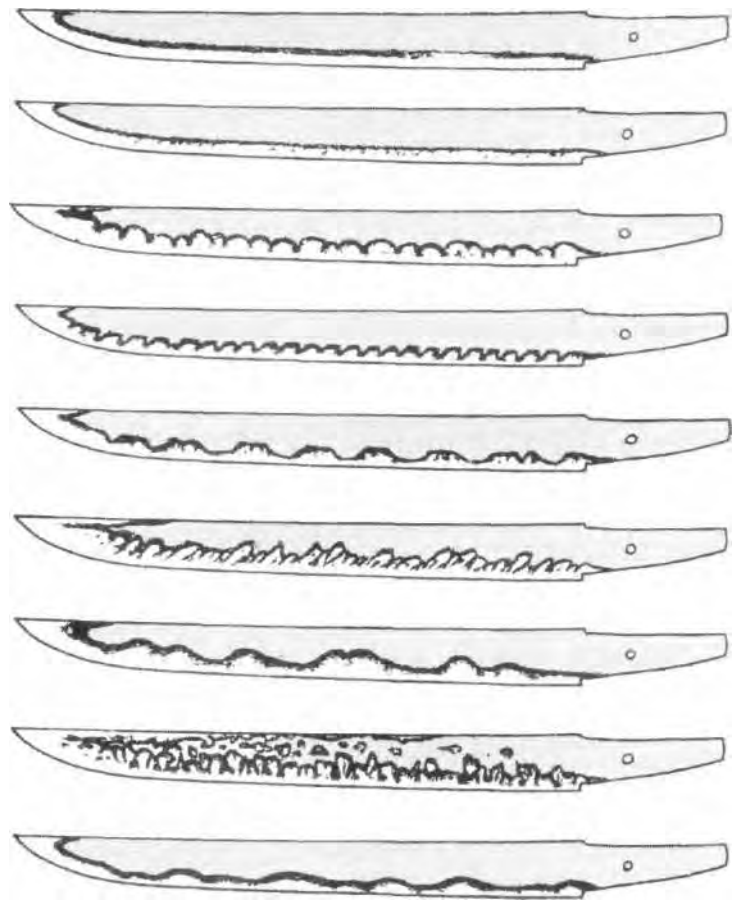

(hu) —

(Hiro) —

(It) —

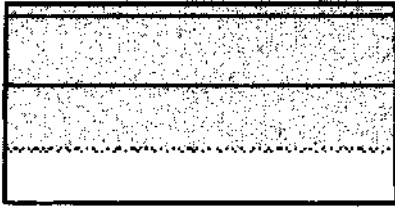

(Suguha)

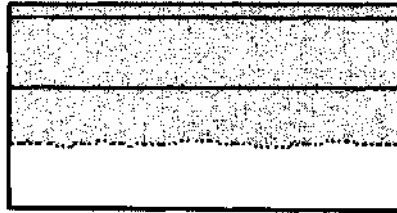

(Suguha-hotsure)

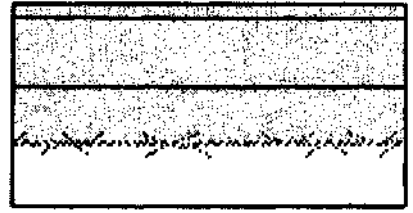

(Suguha-nezumi Ashi)

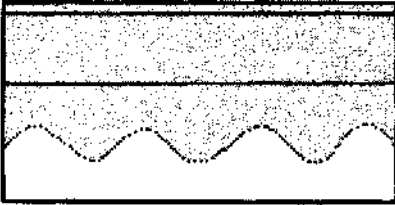

(Notare)

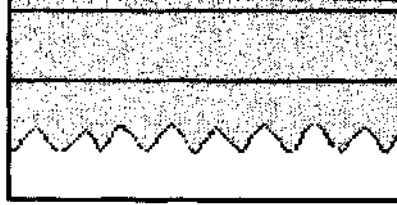

(Gunome)

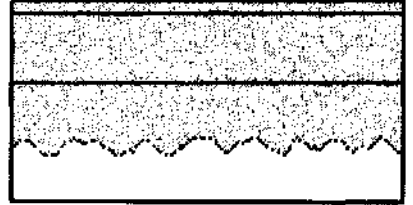

(Midare)

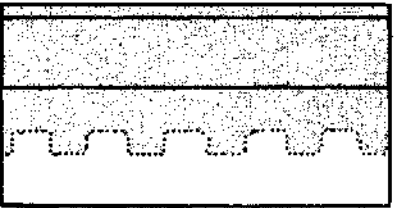

(Hako-midare)

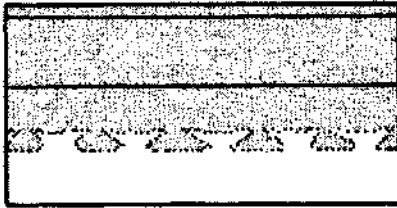

(Yahazu-midare)

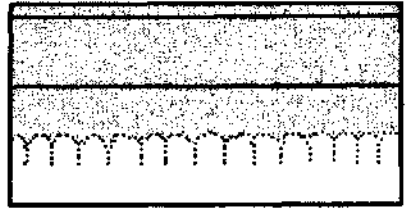

(Choji)

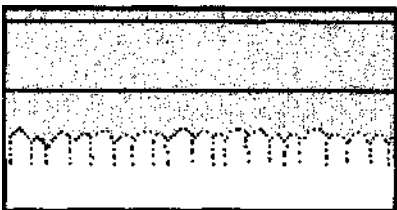

(Choji-midare)

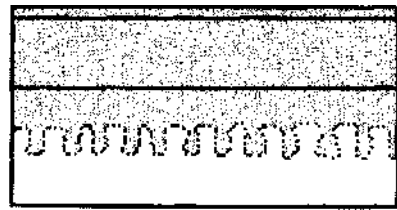

(Gunome-choji)

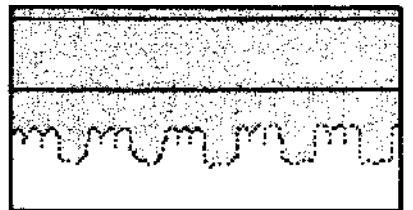

(Gunome-sambon Choji)

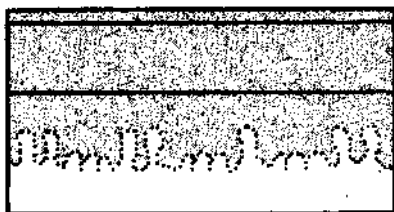

(Kawazu-no Ko-choji)

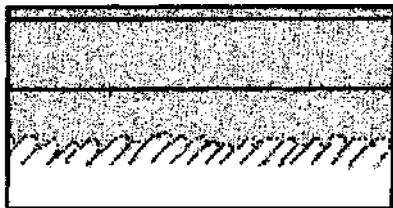

(Saka Choji)

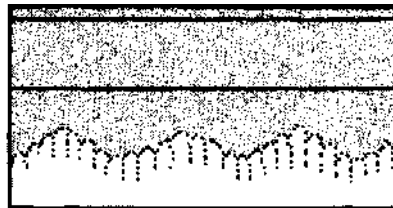

(Juka Choji)

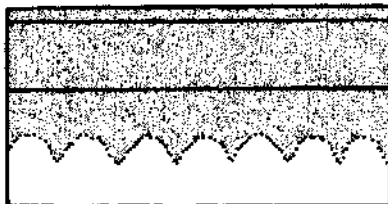

(Juzuba)

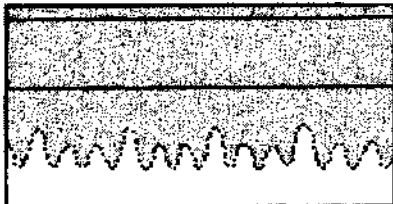

(Sambonsugi)

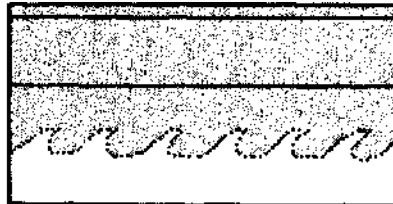

(Nokogiri-ba)

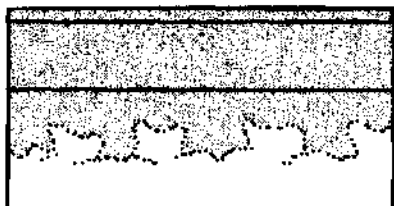

(Mimigata)



(Kikusui)

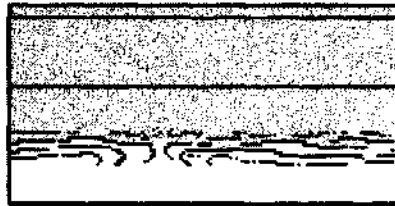

(Sudare)



(Hitatsura)

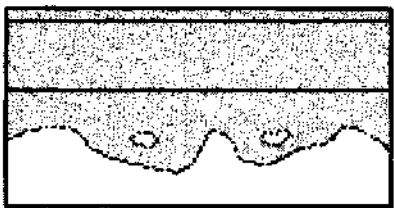

TOPAH-XA
(Toranha)

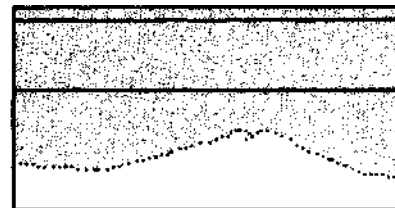

(Fuji)

()

« ».

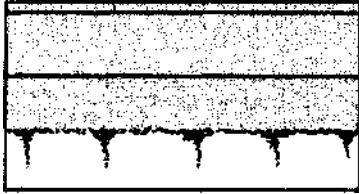

(Ashi)

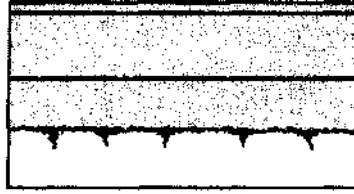

(Ashi)

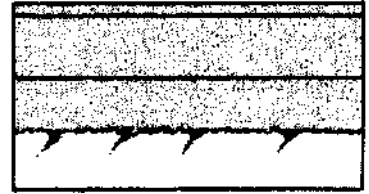

(Saka Ashi)

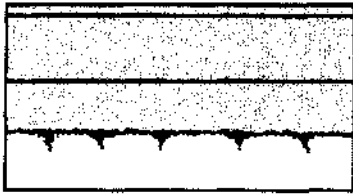

(Choji Ashi)

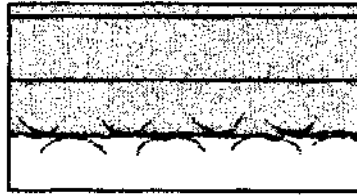

(Nezumi Ashi)

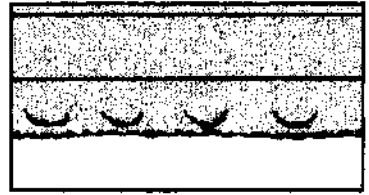

(Uchi-no ke)

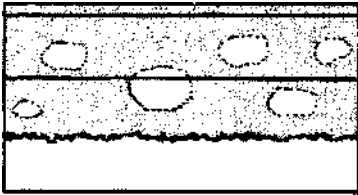

(Tobiyaki)

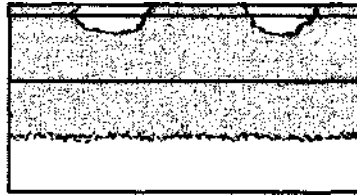

(Muneyaki)



(Utsuri)

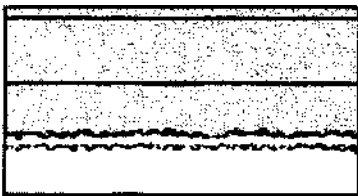

(Nijuba)

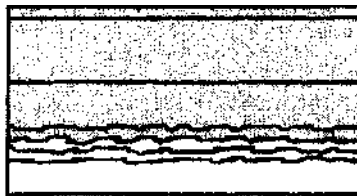

(Sanagashi)

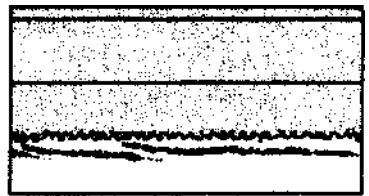

(Kinsuji)

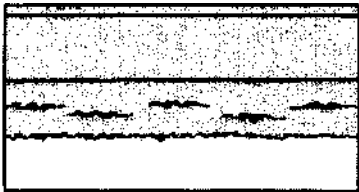

(Chikei)

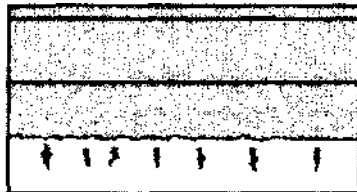

(Yo)

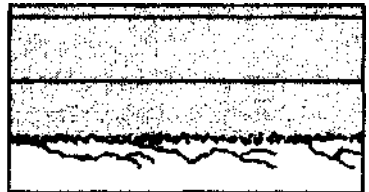

(Inazuma)

« » (Boshi),

« »

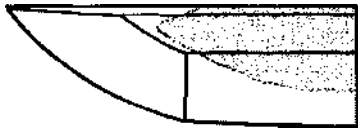

(Ichi Mai)



(Yakizume)

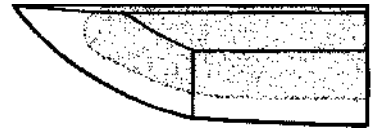

(Omaru)



(Komaru)



(Komaru Nieru)



(Ichimonji Kaeri)



(Kaeri Asashi)



(Kaeri Fukashi)



(Kaeri Buka)



(Kaeri Tsuyoshi)



(Midare Komi)



(Notare Komi)



(Jizo)



(Kaen)



(Choji Midare Komi)



(Yokote Uehososhi)



(Nie Kozure)



(Hakikake)

Ji,

« »,

- *(Masame Hada)*



- *(Mokume Hada)*



- *(Itame Hada)*



- (*Ayasugi Hada*)

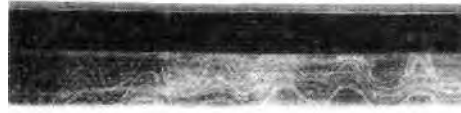

- (*Nashiji Hada*)

« »

- (*Konuka Hada*)

- (*Bizen Hada*)

« ».

My - (*Muji Hada*)

"Mu" — , "Ji" —

« ».

Ji Showa-to (

, 1925-1989 .)

(*Shin-gunto*,

«

»),



* * *

(*Hi*).

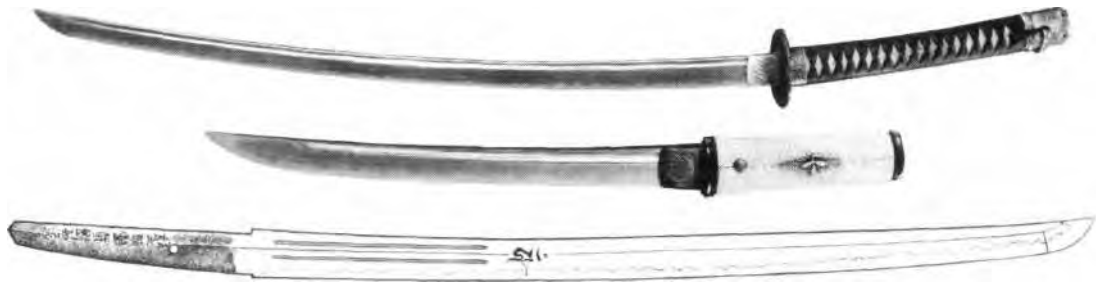

« ... (...),
 ».
 (Horimono).

« ... »,

(Kanji),

(...).

« ... »,

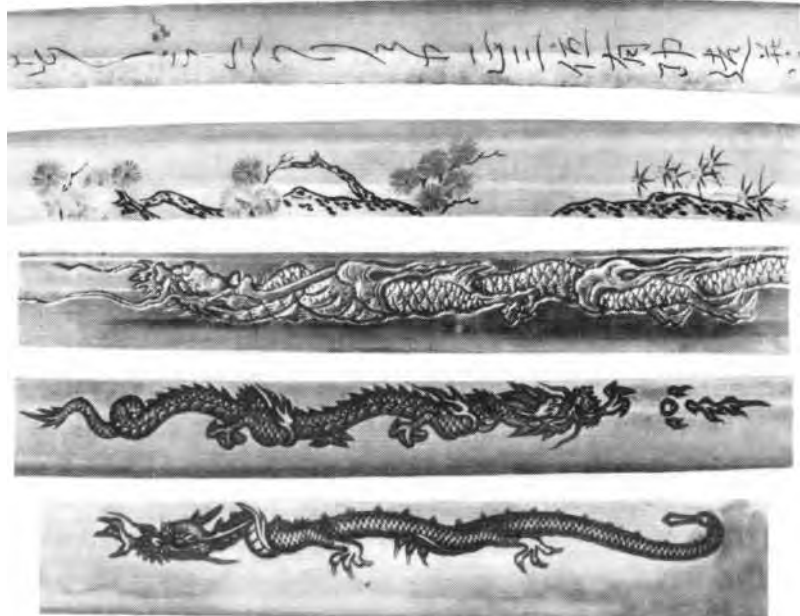

* * *

- *(Soshu Den)*

XIII

« - ».
 « - » (« - »).
 (« - ») « - »), « - », (Hitatsura).
 « - », « - », « - » (Kengyo):



- *(Bizen Den)*

« - » (), « - », (), « - ». (Utsuri).

(1394-1428)

(« - »):



- *(Mino Den)*

(), (Sanbon Sugi), « - ». ()

(Higaki), (Sujikai) (Kiri):



(Yamashiro Den)

(Ji Nie)

(Nashiji) — « »,

700

(« »),

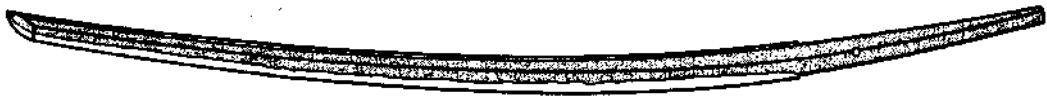

(Yamato Den)

(Ashi-iri).

« ».

(Senjuin),

(),

(Shikkage),

(Shizu)

(Tegai):



М
Е
Ч
А

Т
Е
Х
Н
О
Л
О
Г
И
Я



(Hamon),

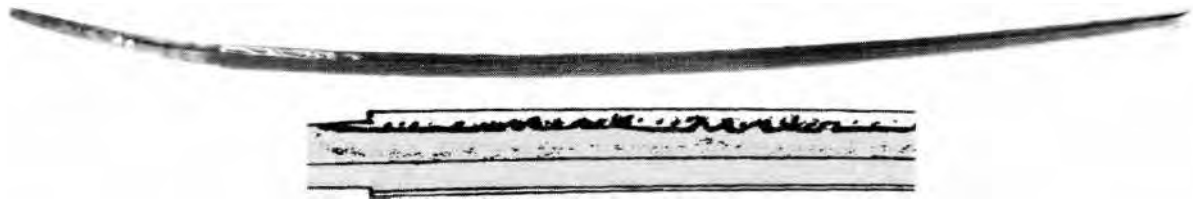

— () —

— (Yakiba) —

— (Habuchi) —
(Ji),

). (Hamon),

« (Nie) (Nioi). »

« »

(Tabiyaki).

Ji.

« » (Hada)

32 000
250 000

« » (Satetsu).

(Tatara)

tamahagane

0,6 1,5%.

1,5%

shingane (0,5%)

kawagane (1,5%).



—

« - »,



Hon-Sanmai-Gitae

(Hagane):



« - »,

! *Shingane*
0,5%-

tamahagane

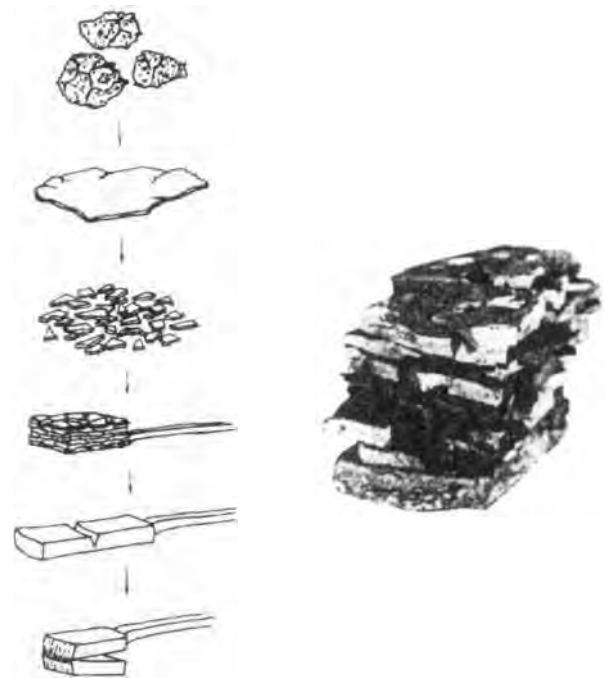

kawagane

shingane

kawagane:

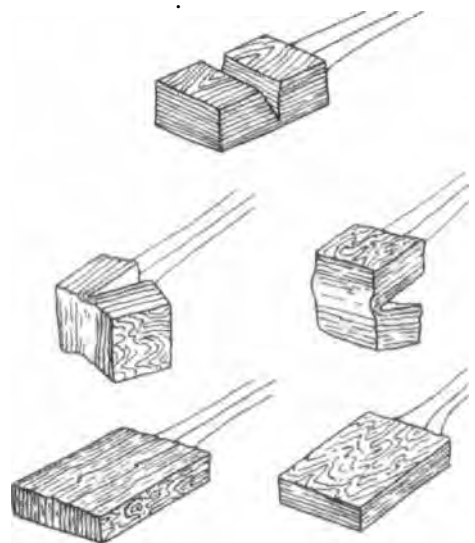
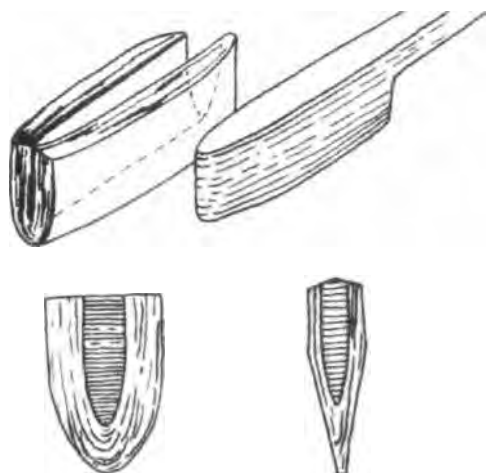

(— , —)

« » (Shiage) —

(Sen).

« ».

()

« » (Tsuchioki)

()

(!)

«

»,

— (Yaki-ire) —

XIV

(

«

- 50%
- 30%
- 20%

() ,

(NaOH)

« »
()

NaOH

(!) —

18

« »,
(830°),

2

5-6

()

« » (Ashi)

Ashi

120-130°

Ashi

()

Ashi

« » (Boshi),

830°

4.



195-200° .

(Horimono).

(

xu (Hi)

(Mei)
)

(Honnami)

(Fujishiro),

XIII

3000

- (Uchigumori -) —

- **-mo** (Uchigumori Ji-To) —

(Shiage-togi)

».

()

- (Hazuya) —

- (Jizuya) —

(Marutaki),

(Nugui) —

, « »

* * *

— « - » (Hadori) « » (Sashikomi).

NBTHK

М
О
Н
Т
К
Р
О
В
К
А

М
Е
Ч
А



(, 1905 .)

(- .)

« - »

« - », (

« » (Koshirae),

, « - » (Kodogu) —

« » « » (Saya),

).

?

?

() « »
 — « - »
 , ,
 , ,
 « »
 « » (Ishizuke)



« »,
 ()
 ()

XIX — XX ()
 « - » (« »),
 ()



(Kurikata)
 (Obi-tori)

() ,

(Ashi)

(Shibabiki)

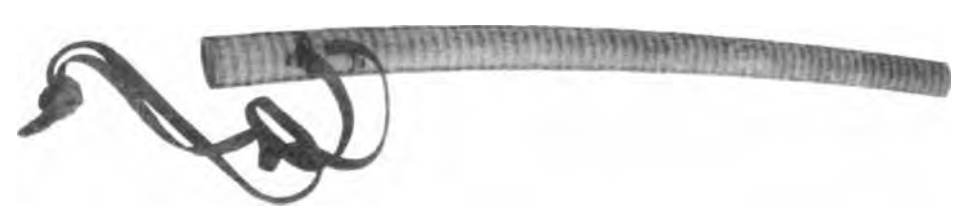



(1)

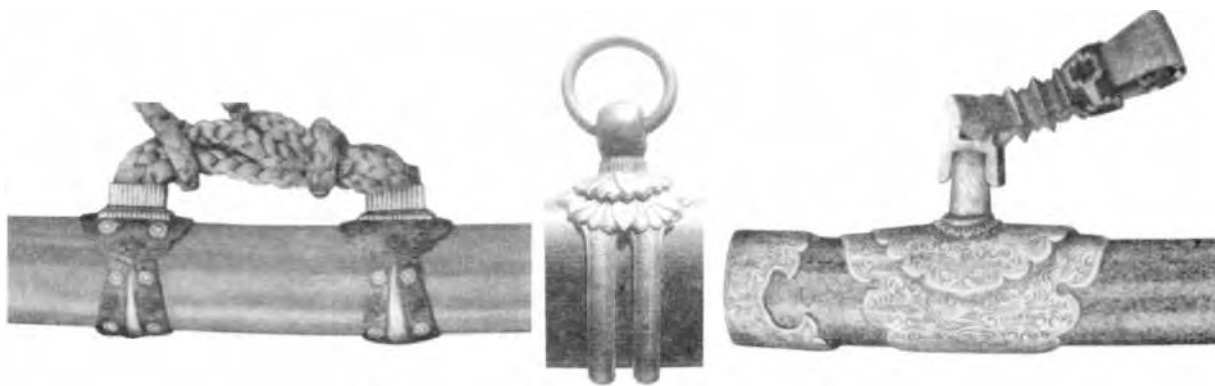

« - »

» (Koiguichi),
(Kuchi-gane). E

« »,



5.



« »,

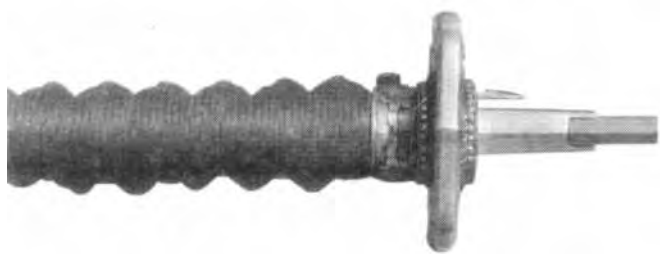

(« »).

»),

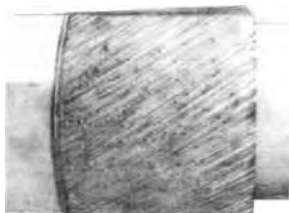

— Yasuri-me

« »

« »

* * *

« » (Seppa).

« »



« » (Tsuka),





« »

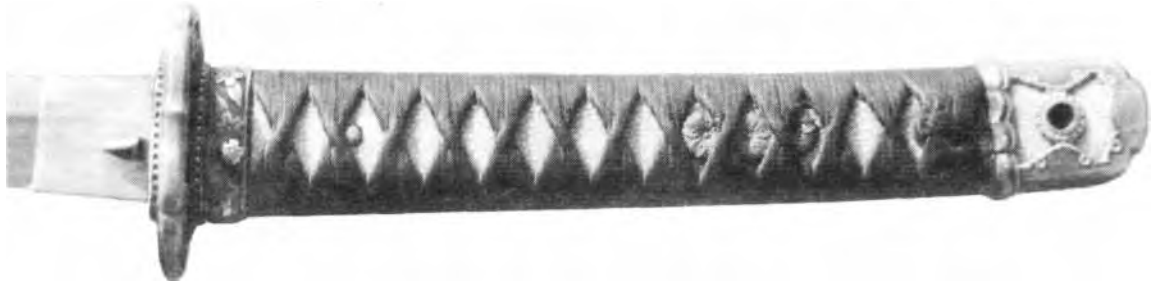

« »,

« - »,

« »



(« »)

(Hinerl-maki) —

(« »)

(Katahineri-maki) —

- (Tsumami-maki) — ,
 - (Handachi-zuka) — , « - »,
 - (Hira-maki) — . « » - (« »)
 - (Katate-maki) — , -
- , , , - , , « - », « - » («Bushido» 1980).
- (1). 10 () 5 ().

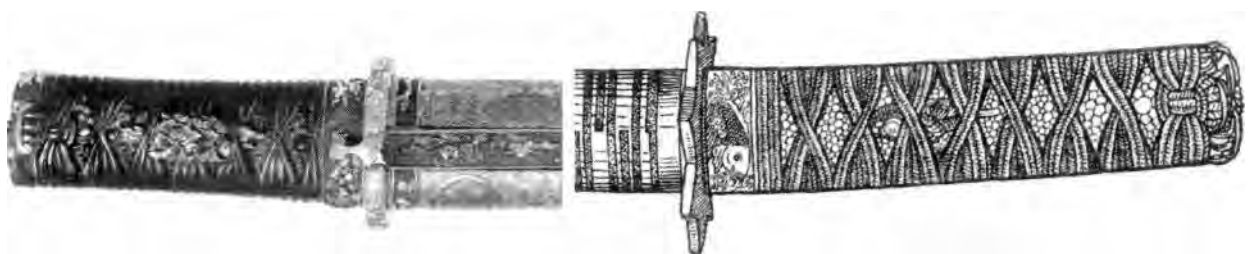

« - » (Makidome), - , ()

: « — - ».

: « » (Kashira) « - » (Kabutogane),

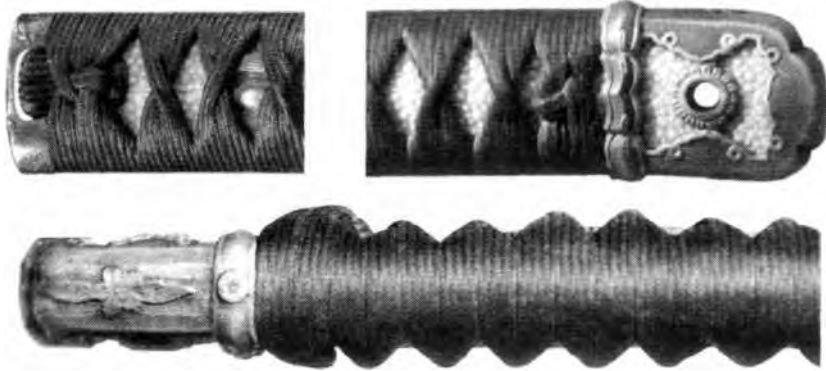

»),



» (),

» (Same Kawa).

« »

— « ».

() « » (Fuchi),



(« ») 10 25 ,

« »

(- , -)

(Menuki),

— ,

« »



« - » (Hari Menuki):

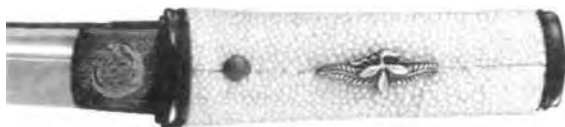

»

« -

« » (Nio)

()

« » « »

« ».

(« - »)

* * *

« - » —

: « » (,) « », « ».

« »

X

?

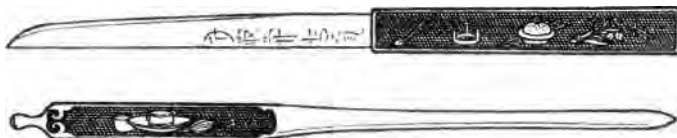

« » - « », « », « ».

300

« »

!

(,)

(« - »)



(« »)

« - », —

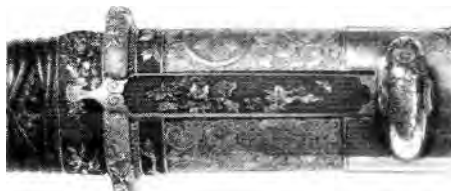

« - » (« »)

« » (,),



») — () , « - » (« -
 ,
 ,
 ,
 (« »)
 « » , -



,
 , — , ()
 ,
 « - » (Shitodome),

* * *

Ц
У
Б
А





(« »)

(« ») « - » (Hitsu Ume). He



(!)

()

()

« »

()

« ».

XVIII-XIX

« ».



« - ».

« - ».

».

« - » (« »).



« - ».

(,).

« - »

(Sekigane) « - » (Kuchibeni):





« »

3-4
99%

75-85

40-50
60-70

(Maru-gata)

« »

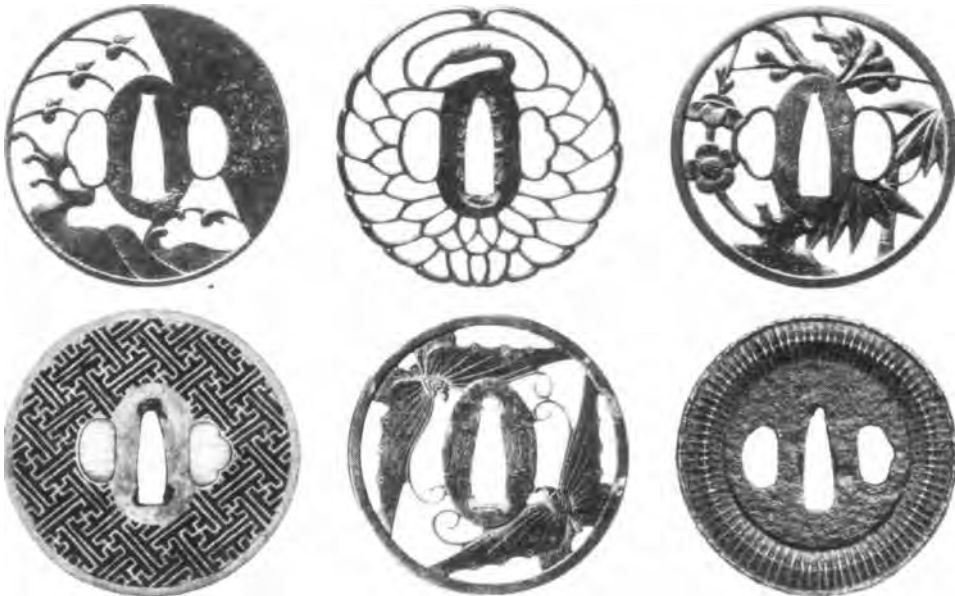

(Nagamaru-gata)

(

), —

(Nagegaku-gata).



(Kaku-gata)



(Mokko-gata)

« »,
 « »
 « - » (« »):

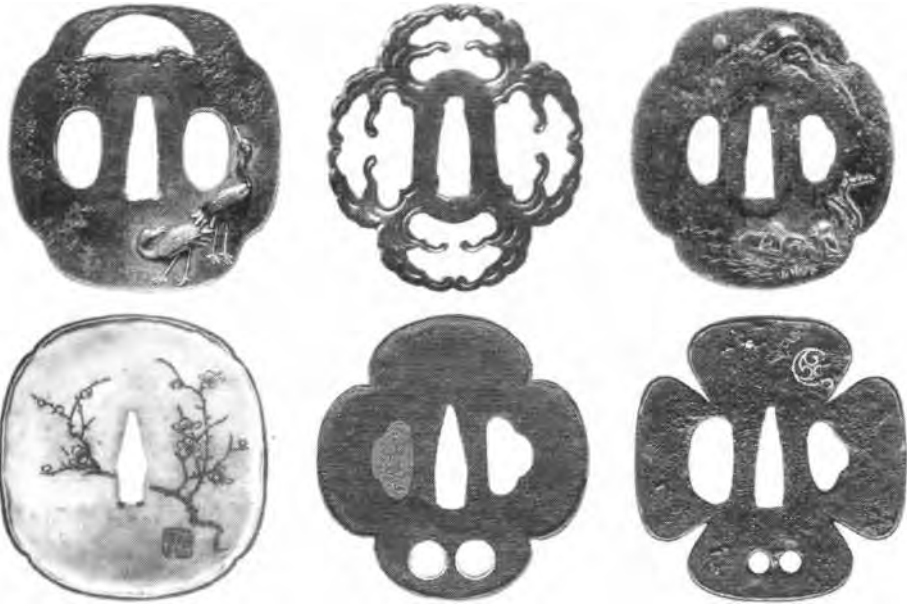

« - »

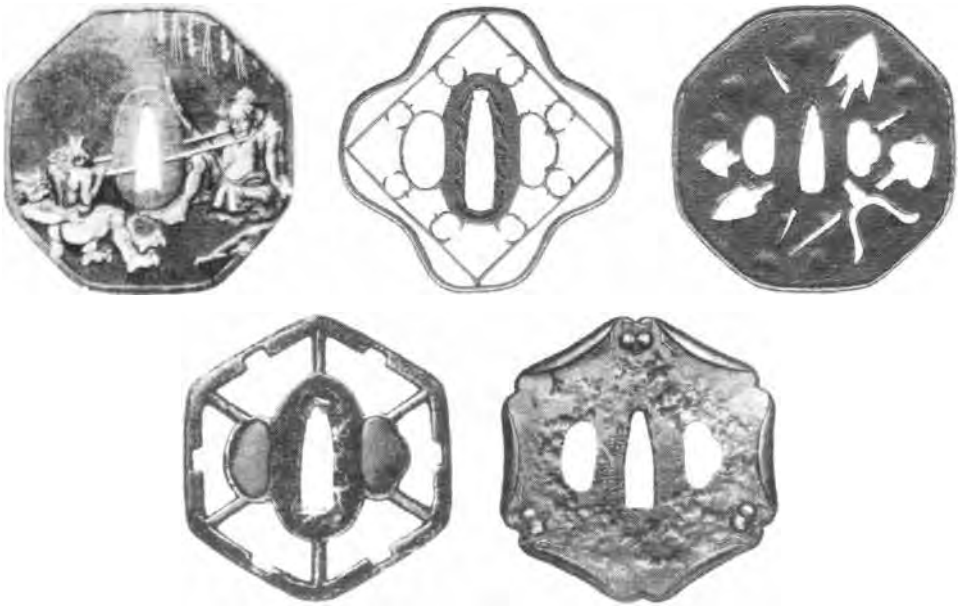

Aou (Aoi-gata)

« », « », « », « », « », « ».

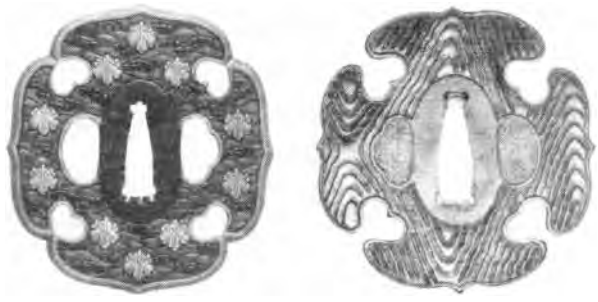

(Shitogi-gata)

, « » -
-
, . -
:



, , -
, , -
:





— « » (Sho), « ».

« » (Mimi).

(« - »)

(« »).

« - » (Uchikaeshi Mimi).

(« »),

(« »)

(« - »)

(« - »)

XVI

»,

)

« - »

« » (Sukashi)

« » (Tekkotsu),



» (Shakudo),

70%

(

«

—),

« » (Sentoku).

« » (Shibuichi)

« - »,

().

XVI —

XVII

« » (Namban),

XVII

XVIII

(Kin),

(Gin),

« »,

П
О
Д
Д
Е
Л
К
И

М
У
Л
Я
Ж
И
И

!

(— ,)

(. . .)

« », « » « », , , -
« »

! !» — : «
?!» (- .).

—

« »

» « » « »

« » « », ,

), (

90%

« , , , - - ...»

10%

« » —

40X13,

« 440»,

« ».

50 HRC

« ».

« »,



« »

5 10

« »

(!)

(

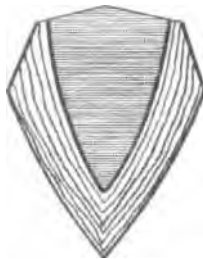

« »

« »,
: « !»

8

3-4



7.

65

?

3,5

8

3-4

— 99%

7

« - ».

« »,

():



XXI

»

(?)

« »:







()

« - »

«

»

XIII,

?

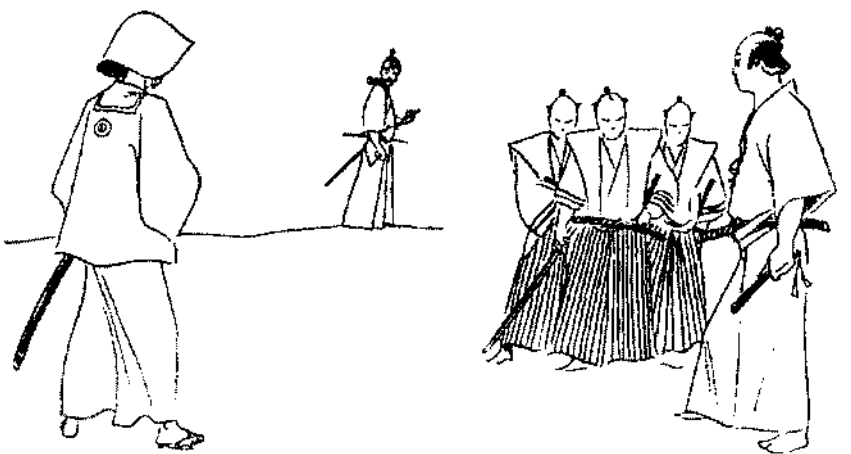



(1657-1725)



«

: «0

!»

».

XIX - XX

«

...»
(. . .

, 1894 .)

1.

2.

3.

4.

5.

6.

7.

(Fuduka),

(),

8.

9.

(Kizu) —

10.

* * *

?

?

«

»,

«

»

(Mekugi-nuki) —

(Uchiko) —

8000.

30

« — »,

(Mugui-gami) —

— (Abura) — , (« »).

— (Abura Nuguishi) — .

1.

2.

3.

4.

5.

6.

7.

8.

9.

10.

11.

12.

(!)

() .

3x6

: «

?» —

« — »,

),

(Shira Saya),

«

»



XVII—XVIII



).

» (Hiki-hada).

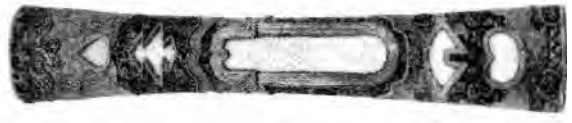

(!)

(!)

(

),

«

»,

(

),

()

XVII

«

».

? —

»,

:

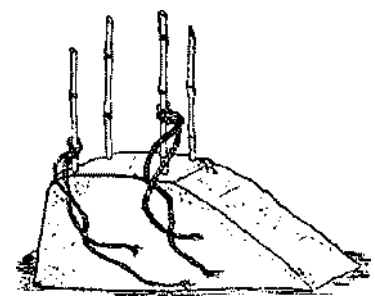

« - » ()



- (—):

1. - (Ko-kesa)
2. (Kesa) - (O-kesa)
3. (Sodesuri)
4. - (Hiji Tachi)
5. - (Tachiwari) - (Kami Tachiwari)
6. - (Tai Tai) (Suritsuke)
7. (Karigane) (Wakige)
8. **Tu- apu** (Chiwari) - (Ichi-no Do)
9. (Wakige) - (Ni-no Do)
10. -(Suritsuke) - (San-no Do)
11. - (Ichi-no Do) - (Hondo)
12. - (Ni-no Do) *Xamu-* (Hachimaime)
13. - (San-no Do) (Kurumasaki)
14. (Kurumasaki) - (Ai-no Kuruma)
15. - (Rio Kuruma)
16. - **apu** (Shimotatewari)
17. - (Hiza Tachi)
18. - (Tabigata)

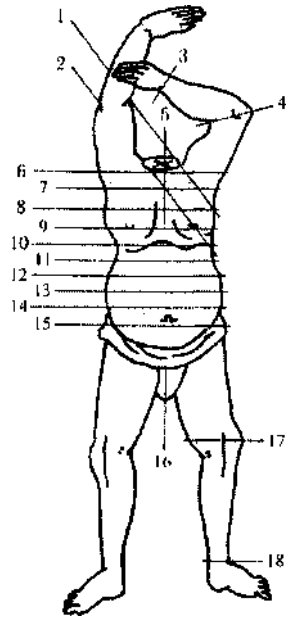

(15, « - -

»), — (2, « »).

(),

».

«Sword and Same», Henri L. Joli

& Inada Hogitaro (1913).

— ! ()

, — « », « ».

- , « »,

- ,

— , —

, ,

« »,

(,

)

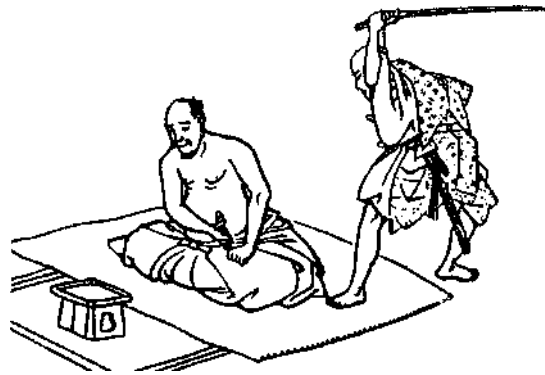

« »

»,

(« »),

« ».

« »,

М
Е
Ч
О
М

В
Л
А
Д
Е
Н
И
Е



!»

».

(,)

(« - »),

« ».

XVIII

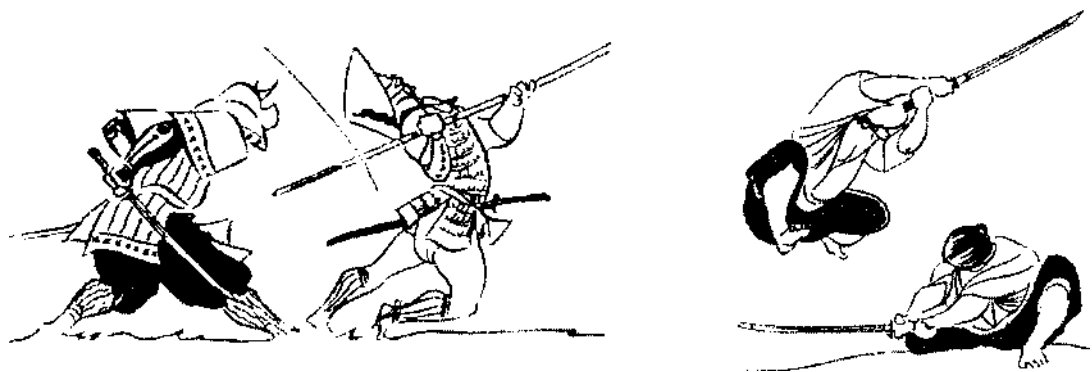

360

XVI XIX)

«i».

IV

(1387-1488),

1960

« »,

XVI

XV

(, 1452-1538),
XVI - XVII

« »

XVIII XIX

« » « » « » « » « » « » « »
» « » « » « » « » « » « »
» ? « » « » « » « » « »
« » « » « » « » « » « » « »

XVII

(1537-1606),

(« - »).

(1751).

()

?

(, ,).

« »

« »

« »

* * *

() -

(« - »)

(« - »)



1»,

« - »,





« » ()

« » (« »).



—
().

« » (),
» (Te-no Uchi)

* * *

« »
» () :
(),

()
« »
10).







«

»



(-)



« »





« »,

-

.

,

.

—

,

,

,

,

.

* * *

,

,

,

.

,

,

.

,

-

,

.

С Р
В У
О К
И А
М М
И И



, —
!
()

...
!
()

« », —

(,) ,

()

» ,

() ,

(12, 13) — (65 , 40X13),

« » (— 12).



35 , — 9,5
— 27 5 , — 20 6 .

0,2-0,5

— « »

— « - » « - » (!)

« »

1

« » « ».

« ».



« » (

),

« »

20

« ».

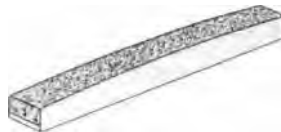

« », « - » « » (. « »).

)

* * *

()

(!)

(- — « »)

- 405° ()
- 480° - ()
- 530° - ()
- 535° ()
- 576° ()
- 580° ()

746°
 800° -
 843° -
 900° ,
 940° -
 1000°

;

(!)

() .

« » .

* * *

!

« » .



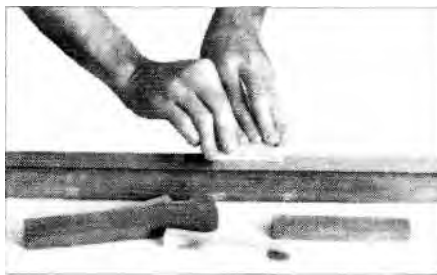

10 15 50

(, ,)

« » — « »

90%

».

300-500

25°

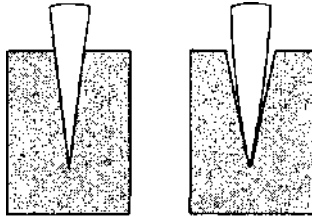

»

« »

« »

« »

« »

»

) (1-6)

— « -
(99,5%

« »

— « ».

novacula — « »), « ».

»,

— «

(— 100000).
(« »),
« »,
« »
(« »),
« »
* * *
? () « »,
()
(!) 4 (),
« » —
60
« »

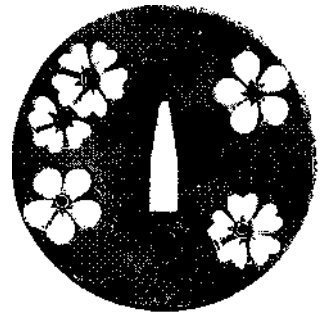

1 . (,)
, — « ».

« », « », « - » « - »

, ()

2 — 5 — 45)

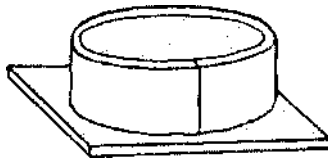
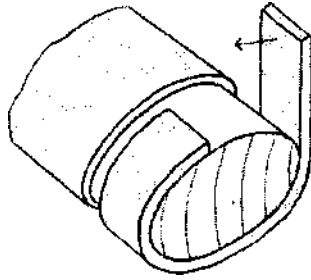

», « »

», « ».

— —

», « - »

2-2,5

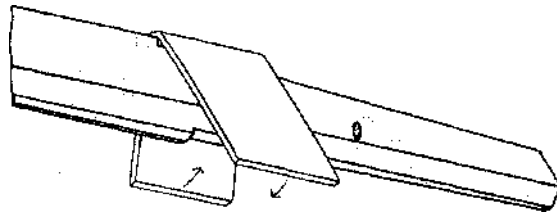

« »

:

)

« » (

2-3

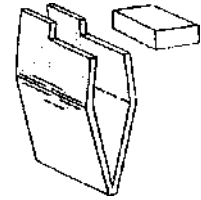
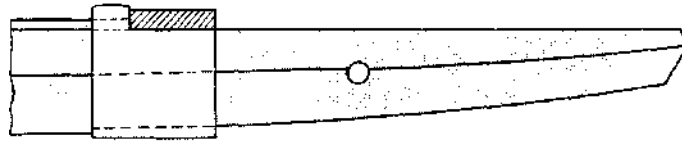

« »

()

?

() 300 45 15

« - »

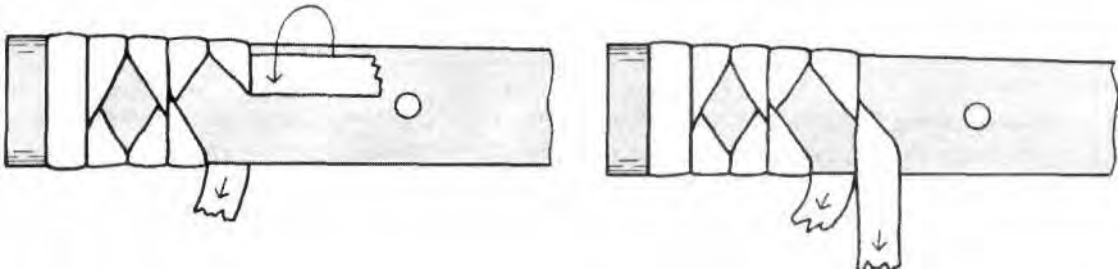

« - » (Hishi-game)

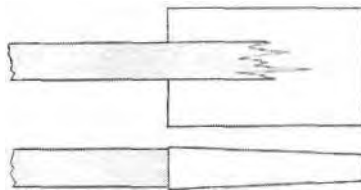

():

1-2.

3-4.

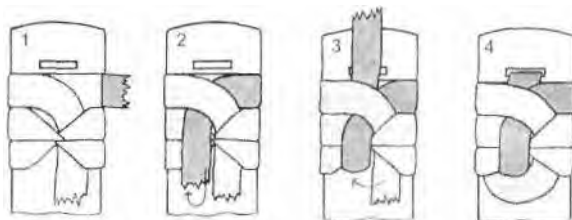

« » ()
« » ().

5-6.
7-8.

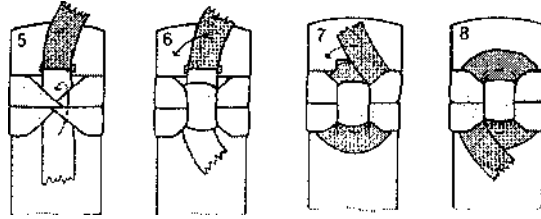

4, 7 8

« ».

800 70x35 ()
)

15

« »

180° —

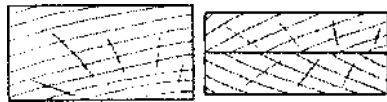

« »,



10.

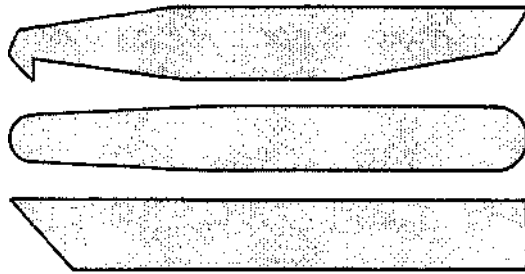

(
).
!
« ».
« »:

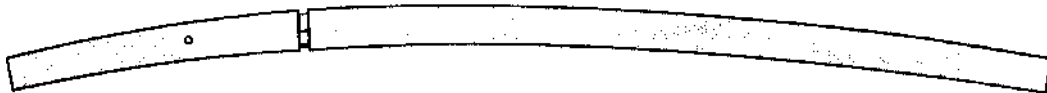
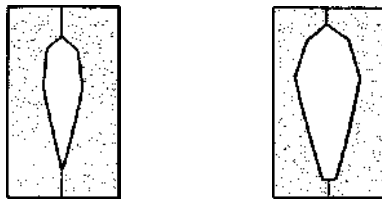

()

« »
2—3

8-12

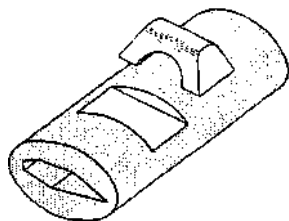

()

8-9

5-6.

« »

« »

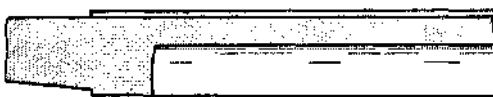

« »

10.

— , -

« » « ».

« »

:

().

« — »,

!



,

— , , , —

,

()

).

()

!

« »

(

)

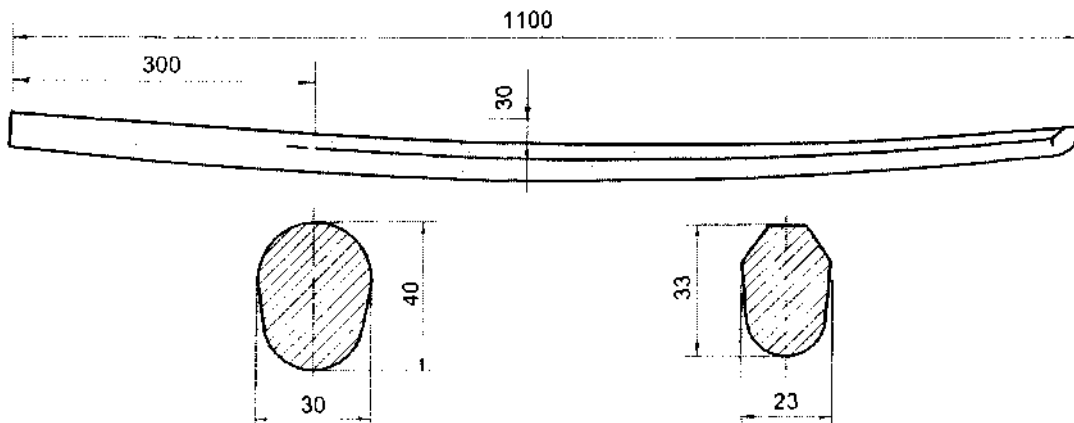

(« »),

30

40
100 110 ,

120

()

* * *

<< - >>

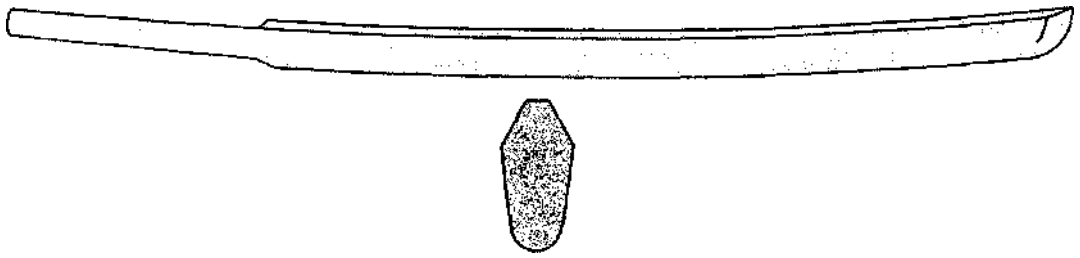

* * *

XXI

2001

?

?

?

?

»

П
Р
К
Л
О
Ж
Е
Н
И
Я



		VIII .		
(Nara).....	710	794 .		
(Heian).....	794	1185 .		
(Kamakura).....	1185	1333 .		
- (Nambokucho).....	1333	1392 .		
(Muromachi).....	1392	1573 .		
(Momoyama).....	1573	1603 .		
(Edo).....	1603	1868 .		
Chokuto (Tsurugi).....		,		<i>Nihon-To.</i>
Koto«	»,		1596 .	
Suo-koto	,		1500	1595 .
Shinto«	»,			1595 1790 .
Keicho Shinto	- ,		1595	1615 .
Kanbun Shinto	,		1661	1673 . (),
Shin-Shinto«	»,		1790	1876 .
Bakumatsu	,			,
	1853	1868 .		
Gendaito	,			1876 .
Meiji-To	,			, 1868
	1912 .			
Taisho-To	,			, 1912 1925 .
Gunto«	»,			-
	1876	1945 .		
Kai-Gunto				-
	,			,
Kyo-Gunto	- ,			(-
) .
Shin-Gunto				, -
				.
Showa-To	,	1925	1989 .	
Shinsaku-To«	» ,			1955 .
		(<i>Sori).</i>
Ken	(<i>Sori).</i>
Nihon-To	().
Daito			70 .	
Tachi	,			,

O-Dachi		60	(, ,
	- , -) .		
Ko-Dachi	(. .)	60	(-
	,) .		
Uchi-Gatana	,	()	()
	.		
Koshi-Gatana	,	-	-
	.		
Katana		70-75	,
		()	,
	.		
Daisho	(<i>Katana</i> + <i>Wakizashi</i>),		: « -
	».		
Wakizashi		60	,
			: «
	».		
Tanto		20 40	,
	<i>Wakizashi</i> ,		
O-Tanto	« <i>Tanto</i> »,	40	.
Aikuchi	,		<i>Tanto</i> .
Yari			
	50	2 3	.
Naginata		(« »)	
	(2)		-
	,		-
Nagimaki	(« ») —	<i>Naginata</i> ,	,
	.		
	.		
Sukuri		
Shinogi-zukuri (Hon-zukuri) .			<i>Shinogi</i> .
Hira-zukuri	,		<i>Shinogi</i> .
Ken-zukuri	()		
	.		
Moroha-zukuri	(<i>Moro-ha</i>)	,	-
	Koto Tanto.		
Shinogi	,		,
	.		
Mune		
Iori-mune	,		,
	.		
Mitsu-mune		(-
).		

Maru-mune
Hira-mune
Machi	,	<i>Habaki,</i>	
		<i>Nakago.</i>	
Ha-machi	()	.
Mune-machi	()	.
Sori
Koshi-zori
Torii-zori
Saki-zori
Mu-zori	(<i>Tanto).</i>	
Uchi-zori	()
)	.	
Omote	(<i>Katana</i>	<i>Tachi).</i>
Ura	,	<i>Omote.</i>	
Nagasa	<i>Nakago,</i>	<i>Kissaki</i>	<i>Machi,</i>
Mihaba
Motohaba	<i>Machi.</i>	
Sakihaba	<i>Yokote.</i>	
Katahaba
Funbari	,	.	.
Kasane
Kissaki	,	.	.
O-kissaki
Chu-kissaki
Ko-kissaki
Ikubi-kissaki«	»,	<i>Kissaki</i>	.
Yokote	,	<i>Kissaki</i>	-
	.	.	.
Shinogi«	<i>Shinogi</i> »,	,	.
	<i>Kissaki</i>	.	.
Mitsukado	<i>Shinogi,</i>	<i>Shinogi</i>	<i>Yokote.</i>
Fukura	<i>Kissaki.</i>	.	.
Nakago
Ubu	,	,	(— <i>Nakago).</i>
Suriage	,	<i>Nakago,</i>	
	(<i>Mei</i>)	.	.
O-Suriage	<i>Nakago,</i>	.	.
Funagata	<i>Nakago</i>	.	.
Furisode	<i>Nakago</i>	.	.
Futsugata

Kijimomo«	»,	Nakago,	-
Mekugi-ana			-
	Mekugi.		
Nakago-jiri	,		
Kurijiri		Nakago-jiri,	-
Kirijiri	,		-
	(Suriage).		
Kenjiri	,		
Buke Zukuri	,		-
			-
Jindachi Zukuri			
Koshirae			-
	(-	-
Kodogu	Koshirae		
Saya	(,	,
Shirasaya		,	
Kojiri	,	,	
Ishizuke		Tachi, Kai-gunto	Shin-gunto,
Koiguichi			
Kuchi-gane			
Kurikata«	»	«	» —
		Sageo.	
Shitodome		Kurikata.	
Sageo	,		Kurikata
Kogai			Tanto
	Wakizashi	(Omote)	
Kozuka		Ko-Gatana,	
	(lira)	Tanto, Wakizashi	() Katana
Ko-Gatana	,		
uka	(,	.
Fuchi	,		
Kashira		Katana, Tanto	Wakizashi,
Kabuto-gane			Tachi, Kai-
	gunto	Shin-gunto.	

Saru-te«	» —	()	-
Menuki	,	Kabuto-gane.	
Mekugi	,	()	
Ito (Tsuka Ito)	,		
Same	,		
Tsuba	,		-
Habaki	,		
Seppa	()	,	
Ashi	()	,	
		(Ichi-no Ashi)	
		(Ni-no Ashi)	
Obi-tori	,		
Shibabiki	Ashi	,	
	,		-
Fukusa			
Nuguigami			
Mei	,		
	,	Nakago.	
Mumei«	», . .		
Gimei	,		
Kinzogan-mei	,		
Katana-mei		Nakago,	-
Tachi-mei	,	Tachi (
		Nakago).	
	:	(mote)	Nakago,
<i>Katana</i>	<i>Tachi,</i>		<i>Katana</i>
		<i>Sashi Omote</i>	<i>Sashi Ura.</i>
Naga-mei			
Ni-mei	,		-
	,		

Mon.....	,	,		-
Ato mei.....	,	,		-
Dai mei.....	,	,		-
Dai saku.....	,	,		-
Yasuri-mei (Yasurime).....			Nakago,	
Sujikai.....				
Kiri.....				
Kesho.....				
Higaki.....				
Taka-no-Ha.....	«	»,		
Oshigata.....				Hamon
			Hada,	
Origami (Kantei).....				-
Sho Shin.....				-
Boshi.....	<i>Hamon</i>		<i>Kissaki,</i>	
Ko-maru.....			<i>Boshi</i>	
O-maru.....			<i>Boshi</i>	
Ichimai.....			<i>Kissaki.</i>	
Midarekomi.....			<i>Kissaki.</i>	
Jizo.....				
Hakikake.....				
Kaeri.....		<i>Boshi</i>		
Yakizume.....		<i>Kaeri, Boshi</i>		
Yakiba.....				
Habuchi.....	,	,	<i>Yakiba</i>	Ji.
Ji.....			<i>Yakiba</i>	
Hira-ji.....				<i>Yakiba Shinogi.</i>
Shinogi-ji.....				<i>Shinogi</i>
Nie.....				
			<i>Habuchi.</i>	
Nioi.....				-
			<i>Habuchi.</i>	

Hamon				<i>Nie</i>
	<i>Nioi,</i>		<i>Habuchi.</i>	
: <i>Yakiba</i> ,		<i>Habuchi</i>		
Suguha			<i>H</i>	
Hoso-suguha		<i>H</i>		
Chu-suguha				
Hiro-suguha				
Notare				
Hitatsuraba				
Midare			<i>H</i>	
Gunome				
Choji				
Yo		<i>H</i>		
Ashi				
	<i>H</i>			
Tabiyaki				<i>Ji.</i>
Muneyaki				
Uchinoke				
	<i>H</i>			
Sunagashi			<i>Habuchi</i>	
Inazuma				
	<i>H</i>			
Hakikake				<i>Habuchi.</i>
Kuichigaiba				<i>Habuchi.</i>
Nijuba		<i>Habuchi.</i>		
Sanjuba		<i>Habuchi.</i>		
Kinsuji	«		»,	
		<i>Habuchi.</i>		
Hotsure			<i>Nie</i>	<i>Habuchi.</i>
Yakidashi				<i>Machi.</i>
Yakiotoshi		<i>H</i>		<i>Machi.</i>
Jitetsu		<i>Ji.</i>		
Hada				<i>Jitetsu.</i>
Itame				
Mokume				
Masame				
Ayasugi				
Muji				
Utsuri		<i>Hada,</i>		
			<i>Utsuri.</i>	
Midare				().
Ji-Nie	<i>Nie</i>		<i>Ji.</i>	
Chikei		<i>Nie</i>	<i>Ji,</i>	

Kizu	,	.	
Hagiri		<i>Yakiba.</i>	
Tateware	
Kitaware	().
Muneware		().
Shimi	
Sumi Gomori	
Fukure	
Muneshinae	,	.	
Jiare«	»	.	
Umegane	,	.	
Mu-kissaki«	<i>Kissaki</i> »,	.	<i>Kissaki</i>
Yakinaoshi	,	.	
Mizu-kage	«	»	<i>Machi,</i>
Saho	,	.	
Hajime-no-Saho	,	.	
Owari-no-Saho	,	.	
Reiji		
Reiho (Reishiki)		
Datto	-	.	
Taito	
Teito Shisei	,		()
Teito	,	.	
Rei		
Sensei (Gata)-ni-Rei		
Tachi Rei		
Za Rei		
Rei		
Shinzen-ni-Rei		
Kamiza-ni-Rei	().
Joseki-ni-Rei		
Otagai-ni-Rei		
Arigato	().
Domo	(,).
Domo Arigato	().
Domo Arigato Gozaimasu	().
Dozo	(.).
Gomen Nasai		
Onegai Shimasu	(-	,
)	,	-

Oshiete Kudasai.....« , !» -

Onegai Shimashu
Kudasai,
 «Oshieti Kudasai, Onegai Shimasu»
 « - ?»

Onegai Otsukaresamadeshita
Sumimasen.....« » ().

Te-no-Uchi.....
Shibori.....
Hasuji..... -

Kiri
 — « ».

Seme« ».

Mamori **Seme**
Shini« », , -

Tome
Nobi **Shini**
Kata
Soe« », -
 ().

Tatara ,

Tamahagane.

Satetsu..... ,

Denkai Tetsu..... (99,99%) , -
 , *Oroshigane.*
 r , *Tatara.* (-
), *Tamahagane,* -
 , *Oroshigane.* -

Oroshigane.....

Kangan Tetsu	,			-
Kawagane	(1,0-1,5%)	,		-
Jigane		,	« »	
Shingane	(0,5%)			
Hagane				-
Hon Sanmai Gitae			<i>Hon Sanmai Gitae.</i>	
			,	
			<i>Kawagane</i>	
			<i>Shingane</i>	
			,	
			<i>Hagane</i>	-
Kobuse Gitae		,		-
			<i>Shingane</i>	-
			<i>Kawagane.</i>	
Tsumimakishi	« »		<i>Kawagane,</i>	-
				-
			12 15	
			,	
			<i>Jihada.</i>	
Shita Gitae	,			-
Age Gitae	,			-
			,	
			<i>(Shita Gitae),</i>	-
Tsukuri-komi			<i>Shingane</i>	
			,	
			<i>Sunobe.</i>	
Sunobe	,			
			<i>(Hizukuri)</i>	
Kitae				-
Hizukuri				
			<i>Sunobe.</i>	
Kajioshi (Shiage)			<i>Shiage.</i>	
Sen	,			-
				-
Tsuchi-oki	,			
			<i>Habuchi.</i>	

Omura			<i>r</i> .	
Yaki-ire				<i>Tsuchioki.</i>
Yaki-modoshi				-
				-
		150-200°		
Sorinaoshi				
Nakago-shitate			<i>Nakago</i>	
Togi				
Boken (Bokuto)				
Suburito				
Iaito				
Shinai				
Shinken		, « »		
Shaku		30,2		
Sun1/10	Shaku,	3		
.....1/10	Sun,	3		
Hitoe (Nakago Mune)			Nakago.	
Tsuba Moto				
Chu				
Mono Uchi			()	
Hira			Shinogi	
	Hiraji	Hamon.		
Go Kaden			()	
			(<i>Bizen, Mino, Soshu, Yamashiro, Yamato</i>).	
Nigen Kokuho«			» «	
			» —	
				-
				-
				-
				-
Mukansa				

Kin	()	.
Kin	()	.
Amida Yasuri	,		.
Ana
Aoi
Bori	,		.
Botan
Chidori	,		.
Chu	,		.
Dai
Danbira
Dote Mimi	,		.
Fukurin	,		.
Gata
Gin	,	Shirogane.	.
Goishi	,		.
Hira	,		.
Hiraji
Hira Zogan
Hitsu Ana	Kogai	Kozuka.	.
Inaka Mono
Inome	,		— « -
	».		
Iri Mokko Gata	«	»	.
Ishime Ji
Ito	,	,	.
Iroe	,		-
Irogane
Ita	,		.
Ji	()	.
Jigane
Kagamishi	-	,	.
Kaji	,		.
Kaku
Kaku Gata
Kaku Mimi
Kaku Mimi Koniku
Kanagu	,		.
	Kodogu (seppa, habaki).		
Karagane	«	»,	.
	(20%)	-

Karakuri	,	.
Katakiribori	,	-
Katchushi
Kawagane
Kebori
Kiku	,	.
Kin (Kane)
Kinko	,	.
Kittate	Sukashi,
.....	.	.
Koban	,	.
	Seppa dai.	.
Kogai Hitsu (Ana)	Kogai.
Kokuin	,	.
Kozuka Hitsu (Ana)	Kozuka.
Kuni	,	.
Kusarakashi	,	.
.....	,	.
Maru Gata
Mi mi
Matsukawabishi	,	.
.....	.	.
Mei	,	.
Migaki Ji
Mimi
.....	.	.
Mokume Ji
.....	.	.
Mumei	().	.
Nagegaku Gata
Nagamaru Gata
Nakabiku	Seppa dai (),	.
Nakadaka	,	Seppa dai (),
Nakago Ana
Nanako	,	.
.....	.	.
Nawa Mimi	(Nawa —).
Nerikawa Tsuba	(Kawa -).	.
Niku	,	(, -
). >
Nikuoku
Nunome
.....	.	.
Odawara Fukurin	,	.

Okigane
Omote
Ototsu
Rogin	-	, (50-70%)),
	Shibuichi.		
Sambo-Gin	-	, (33%)),
	Shibuichi.		
Sanari	-	-	,
		Hazama.	-
Sakura	,	,	-
		Sukashi.	
Sekigane (Kuchibeni)			,
	Nakago Ana		.
Sendai Yasuri	,	,	-
		Sendai.	
Sentoku	(/)	.	.
Sen Zogan
Seppa	,	.	.
Seppa Dai	,	Seppa. He	.
Shakudo	3-6% (—	30-70%)
	,	-	.
Shibuichi	— «	»,	(25%),
	-	.	.
Shigure Yasuri	,	.	.
Shinchu	(.	-
).	.	.
Shino Yasuri	,	,	,
	.	.	.
Shippo
Shiremono	,	.	.
Shishibori	,	,	.
Sho
Suaka (Akagane)
Suemon	,	.	-
	.	.	.
Sukashi	().	.
Sukidashi (Sukibori)	,	.	-
	,	.	.
Surituke Zogan	-
	.	.	.
Tachikanaguchi	Tachi.	.
Takabori
Takaniku Zogan
Tekkotsu	,	.	.
	,	.	.
Ten Zogan

Tetsu		
Toban		
Tosho		
Tsubaka	,		
Tsubako		
Tsuchime	,		
Tsuchime Ji	,		,
			-
Ubuzukashi	,	Maru Bori,	-
Uchikaeshi Mimi	,		
Udenuki Ana			-
	,		
Ume	,		
		Sukashi.	
Ura	,		
Uttori			
Yakite Shitate		
Yamagane	,	Nigurome (
	—)	
Yanone (Ya-no Ne)		
Yasuri	,		
Zogan		

1. *Fannin, David; Brumagen, Jarry*. Hamon tempering («Knives illustrated», 1993).
2. *McDonald, David W.* Manual of Handling, Etiquette and Care of the Japanese Sword.
3. *McDonald, David W.* Tsukamaki.
4. *Kenji Mishina*. Japanese Sword polisher.
5. *Quinn, Alan*. Blade Characteristics.
6. *Gilbert, Jim*. Tsuba Terms.
7. *Fuller, David*. Sword making in Shin-Shinto (Bakumatsu) Period.
8. *Das Schwert des Samurai*. Berlin, 1977.
9. . . . , 1993.
10. . . . , 1997.
- , 1979.
12. . . . , 1986.
13. X. (). , 1999.
14. . . . , 2000.
15. . . . , 1999.
16. ; . . . - - , 2000.
17. - . i . - , 1894.
18. . . . , 1987.
19. . . . , 1997.
20. . . . , 1999.
21. . . . , 1997.
22. . . . , 1998.
23. . . . , 1998.
24. , . . . , 1998.
25. ,, F. — . . . , 1990.
26. « » (). . . . , 1981.
27. 11-14 . . . , 1988.
28. 14-18 . . . , 1989.
29. . . .
30. « » , . . . , 1982.
31. - . . . , 1959.
32. - . . . , 1954.
33. - . . . , 1954.
34. « » (. . .). , 1998.
35. , . . . - - , 2000.
36. Stara Bron. Warsawa, 1982.
37. *Dr. Turnbull, Stephen*. Samurai Warfare. Arms and Armour, 2000.



(Tachi),

(Wakizashi)

O-Kissaki (« »).

(Aikuchi)

).



(Saya) —

Ashi

(Kuchi-gane),

— Ichizuke,
Seme-gane

Shibabiki,

Kuchi-gane.

« »

— « » (Shira Saya).



« » (Daisho), — « »,



()

« »

(Kashira)

— XVIII XIX

14—18 33 37 — 18 23



(Fuchi).

37

40

2

20

25

10

20



(Kabuto-gane).



(. . .).

2—4

1—1,5

3

« »,



(Irogane)

XIV-XVI

(Kagamishi),

(Tachikanaguchi)

(Kinko).

1.

(1185—1333),

(1336—1392)

(1392—1573).

2.

(Katchushi).

(Tsubako)

(Hoju)

(Aoi)

3.

(Ko-dogu),

(Mino).

(Shoami),



6x6x2 (3)

(Sukashi)

(Fukurin)

1500 . 67 67 2





(Kaku-mimi).

(1534—1582).

(XIV)
1868)



(Tsuchime),

(Higo),



au

(*Shoami*), 1550 . 72 72 3 .

au

(Owari)

(Tekkotsu) —

1868 .

(1603—

1575 .
. 81 80 5 .

1650 .
. 82 82 5 .

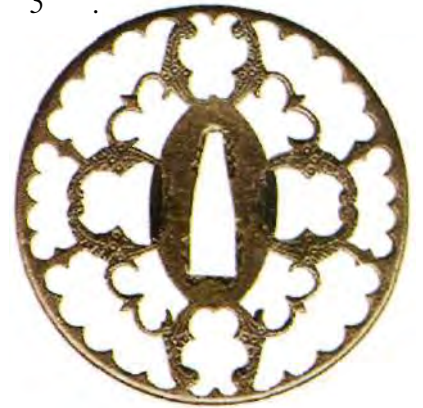

1575 .

73 72 5 .

« » .

-a a

(Shoami)

«Shoami»

« , ».

TM (XVI),

« » —

(Sukashi)

(Katchushi).

— (Kio Shoami)

(Lio Shoami),

(Mito),

(Aizu),

(Awa) ,



— (Unsu Ju Yoshihisa). 80 78 4(6)

(Nunome),

. 81 79 4
XVI ,



(XVII ...)

, 78 78 4



XVI

XVIII ,

: «

. 87 87 5

1725 .

(Shigenobu),



(Iri-mokko Gata)
 10- 2- 1772 .
 : «Matsuyama ju Shoami Morikuni». 84 x 80 x 5(7)



«
 : «Tenka Chuko kaizan Shoami Kinjiro». 77 x 75 x 4



«Tsuba Aigan Meihan Shu Dai Nihen»



1700



VII



: « — « »

XVIII

(Tosho)

(1185—1333)

(1392—1573).

1475 .

— « 76 73 2(4) ».

(Riohitsu),

1475 .

. 81 79 3 .

(Saotome)

(Kiku) —

(Tembo).

(Myochin).

1575 . 86 83 3(4) .



(Shinchu Zogan)

XIV

XVI

(n zogan)

(Suemon zogan).

(Heianjo)

(Suemon),

XVI

(Yoshiro) Ka a.

1450
74 74 2

(Fukurin),

1600

82 80 3

- au

Ka a.

70 68 4(5)

1475



(Choshu)



77 x 77 x 5



71 x 69 x 5



: «Choshu Hagi ji Tomotsugu», 1850



(Kio Sukashi)

XIX

(Katchushi).

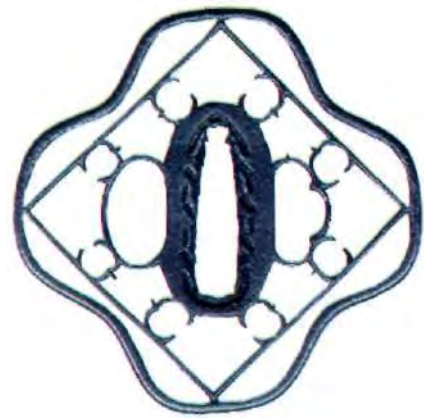

(1185—1333),

()

(. . . XV) .

(Kebori). 80 78 5

69 69 4,5

XIV

Kio

(Tosho)

1650
79 79 5

1650



(« ») .

(Katchushi)

« » .

()

?



92 92 5(7)

(),
(Yasuri)
(Sendai Yasuri —
).

1600 . 84 83 4 .

(Shakudo)

1850 .

(Yanone) —
(Shinshinto),



1500 . 84 84 4 .



1500 . 73 72 2(3)

(Nunome).



85 85 2,5



1400

(Akasaka)

« »

()

1675 . 74 73 5,5

(Kanshoki),

1677 — 1707 (1827).



68 65 4,5

NBTHK

77 73 4,5



(Kunihiro)

(Kunihiro). 1800

71 x 71 4,5



()

XVII . 83 82 4

()

